



# Photocoupler

## Product Data Sheet

### MOC3083 SERIES

Spec No.: DS70-2001-027

Effective Date: 11/30/2016

Revision: E

**LITE-ON DCC**

**RELEASE**

BNS-OD-FC001/A4

## Photocoupler MOC308X series

### 1. DESCRIPTION

#### 1.1 Features

- Isolation voltage between input and output  $V_{iso} : 5,000V_{rms}$
- 6pin DIP zero-cross optoisolators triac driver output
- High repetitive peak off-state voltage  $V_{DRM} : \text{Min. } 800V$
- High critical rate of rise of off-state voltage(  $dV/dt : \text{MIN. } 1000V / \mu s$  )
- Dual-in-line package : MOC3081 / MOC3082 / MOC3083
- Wide lead spacing package : MOC3081M / MOC3082M / MOC3083M
- Surface mounting package : MOC3081S / MOC3082S / MOC3083S
- Tape and reel packaging : MOC3081S-TA1 / MOC3082S-TA1 / MOC3083S-TA1
- Safety approval
  - UL 1577
  - cUL CA5A
  - VDE DIN EN60747-5-5 (VDE 0884-5)
- RoHS Compliance
  - All materials be used in device are followed EU RoHS directive (No.2002/95/EC).
- MSL class1

#### 1.2 Applications

- AC Motor Drives
- AC Motor Starters
- E.M. Contactors
- Lighting Controls
- Solenoid/Valve Controls
- Solid State Relays
- Static Power Switches
- Temperature Controls

## Photocoupler MOC308X series

### 2. PACKAGE DIMENSIONS

#### 2.1 MOC308X

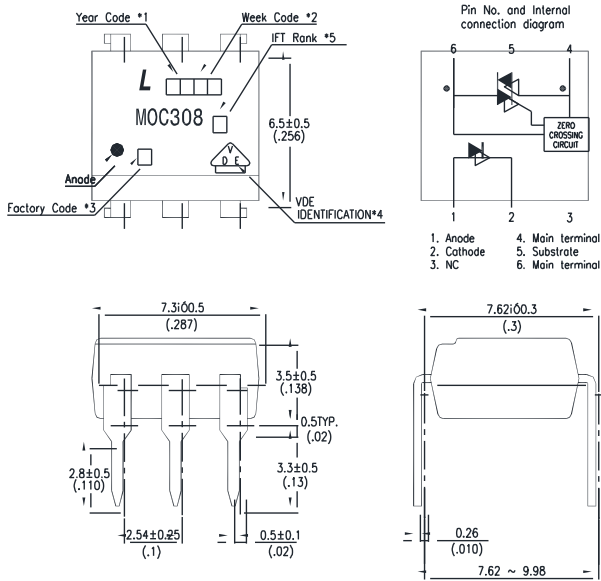

#### 2.2 MOC308XM

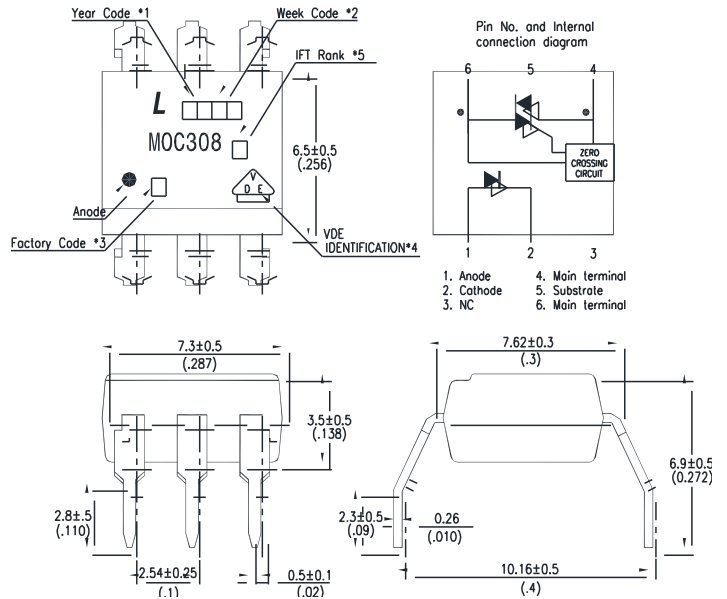

#### 2.3 MOC308XS

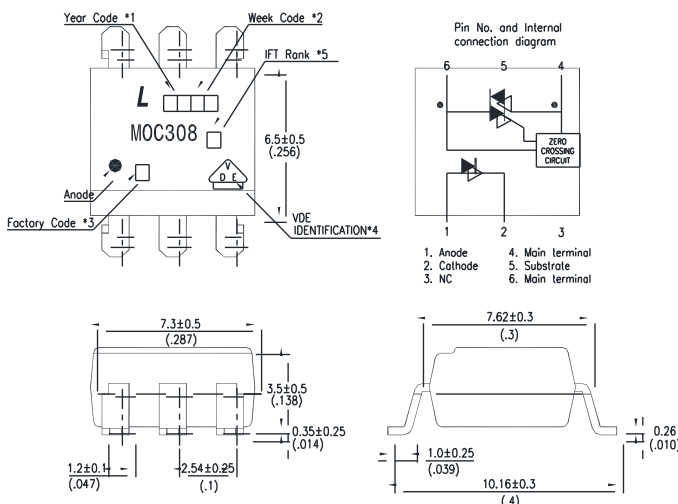

#### Notes :

1. Year date code.
2. 2-digit work week.
3. Factory identification mark shall be marked (W: China-CZ, Y: Thailand)
4. VDE option
5. I<sub>FT</sub> rank

\* Dimensions are in Millimeters and (Inches).

## Photocoupler MOC308X series

### 3. TAPING DIMENSIONS

#### 3.1 MOC308XS-TA

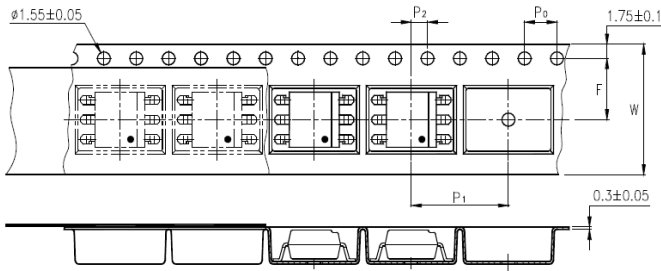

#### 3.2 MOC308XS-TA1

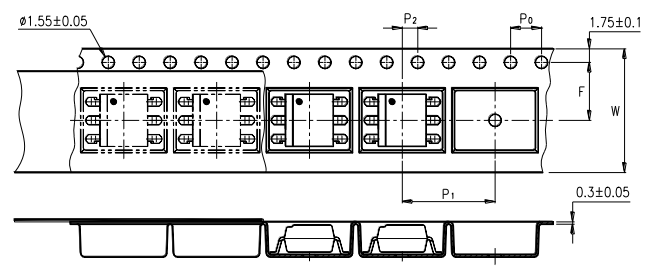

Description	Symbol	Dimension in mm (inch)
Tape wide	W	16±0.3 (0.63)
Pitch of sprocket holes	P <sub>0</sub>	4±0.1 (0.15)
Distance of compartment	F	7.5±0.1 (0.295)
	P <sub>2</sub>	2±0.1 (0.079)
Distance of compartment to compartment	P <sub>1</sub>	12±0.1 (0.472)

#### 3.3 Quantities Per Reel

Package Type	MOC308XS series
Quantities (pcs)	1000

## Photocoupler MOC308X series

### 4. RATING AND CHARACTERISTICS

#### 4.1 Absolute Maximum Ratings at Ta=25°C

	Parameter	Symbol	Rating	Unit
Input	Forward Current	$I_F$	50	mA
	Reverse Voltage	$V_R$	6	V
	Junction Temperature	$T_J$	125	°C
	Power Dissipation	$P$	120	mW
Output	Off-State Output Terminal Voltage	$V_{DRM}$	800	V
	On-State RMS Current	$I_{D(RMS)}$	100	mA
	Peak Repetitive Surge Current ( PW=1ms, 120pps )	$I_{TSM}$	1	A
	Junction Temperature	$T_J$	125	°C
	Collector Power Dissipation	$P_C$	150	mW
	Total Power Dissipation	$P_{tot}$	250	mW
1.	Isolation Voltage	$V_{iso}$	5000	$V_{rms}$
	Operating Temperature	$T_{opr}$	-40 ~ +110	°C
	Storage Temperature	$T_{stg}$	-55 ~ +150	°C
2.	Soldering Temperature	$T_{sol}$	260	°C

1. AC For 1 Minute, R.H. = 40 ~ 60%

Isolation voltage shall be measured using the following method.

- (1) Short between anode and cathode on the primary side and between collector and emitter on the secondary side.
- (2) The isolation voltage tester with zero-cross circuit shall be used.
- (3) The waveform of applied voltage shall be a sine wave.

2. For 10 Seconds

## Photocoupler MOC308X series

### 4.2 ELECTRICAL OPTICAL CHARACTERISTICS at Ta=25°C

Parameter		Symb	Min.	Typ.	Max.	Unit	Test Condition
Input	Forward Voltage	$V_F$	—	1.2	1.4	V	$I_F=20\text{mA}$
	Reverse Current	$I_R$	—	0.05	10	$\mu\text{A}$	$V_R=6\text{V}$
Output	1 Peak Blocking Current, Either Direction	$I_{DRM}$	—	—	500	nA	$V_{DRM} = 800\text{V}$
	Peak On-State Voltage, Either Direction	$V_{TM}$	—	—	3.0	V	$I_{TM}=100\text{ mA Peak}$
	2 Critical rate of Rise of Off-State Voltage	dv/dt	1000	—	—	V/ $\mu\text{s}$	$V_{in}=240\text{Vrms}$
Couple	3 Led Trigger Current, Current Required to Latch Output, Either Direction	MOC3081	—	—	15	mA	Main Terminal Voltage = 3V
		MOC3082	—	—	10		
		MOC3083	—	—	5		
	Holding Current, Either Direction	$I_H$	—	400	—	$\mu\text{A}$	
ZERO CROSSING	Inhibit Voltage	$V_{INH}$	—	5	20	Volts	$I_F=\text{Rated } I_{FT}$ , MT1-MT2 Voltage above which device will not trigger.
	Leakage in Inhibited State	$I_{DRM2}$	—	—	500	$\mu\text{A}$	$I_F = \text{Rated } I_{FT}$ , Rated $V_{DRM}$ , Off State

\*1. Test voltage must be applied within dv/dt rating.

\*2. This is static dv/dt. Commutating dv/dt is a function of the load-driving thyristor(s) only.

\*3. All devices are guaranteed to trigger at an  $I_F$  value less than or equal to max  $I_{FT}$ . Therefore, recommended operating  $I_F$  lies between max  $I_{FT}$ , 15 mA for MOC3081, 10 mA for MOC3082, 5 mA for MOC3083, and absolute max  $I_F$  (50mA).

# Photocoupler MOC308X series

## 5. CHARACTERISTICS CURVES (TYPICAL PERFORMANCE)

Fig.1 Forward Current vs. Ambient Temperature

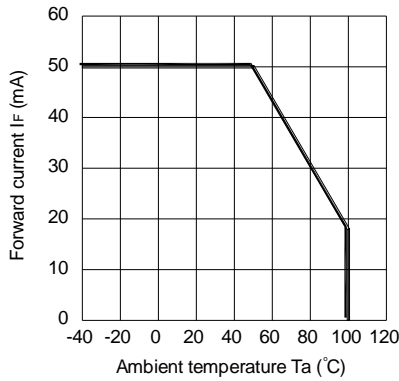

Fig.2 On-state Current vs. Ambient Temperature

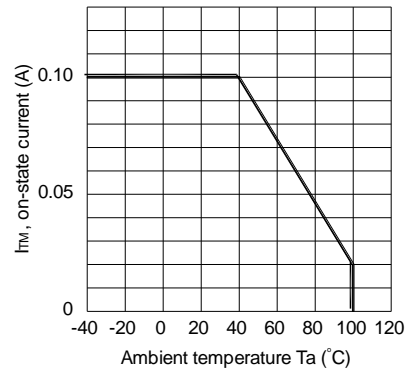

Fig.3 Minimum Trigger Current vs. Ambient Temperature

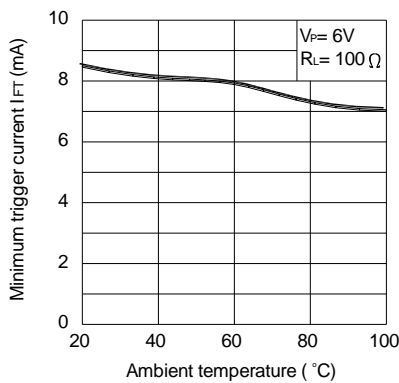

Fig.4 Forward Current vs. Forward Voltage

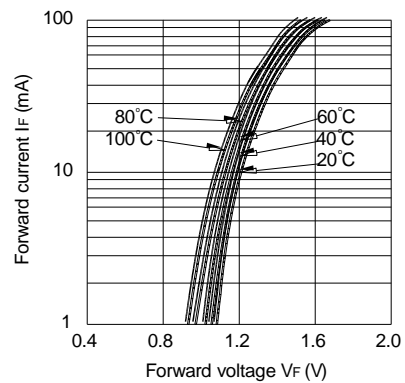

Fig.5 On-state Voltage vs. Ambient Temperature

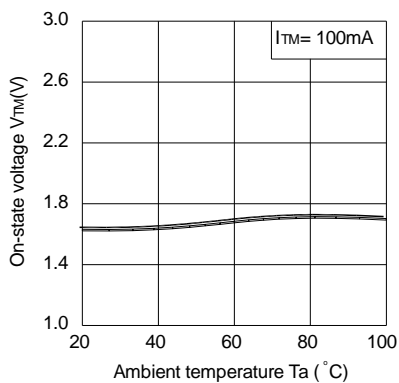
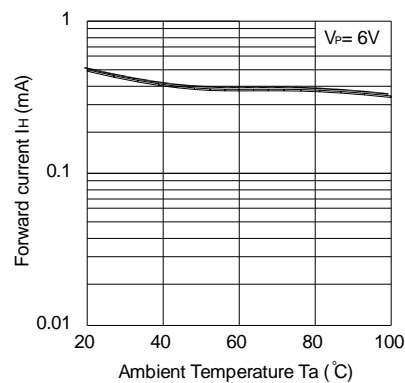

Fig.6 Holding Current vs. Ambient Temperature



## Photocoupler MOC308X series

Fig. 7 Repetitive Peak Off-state Current vs. Temperature

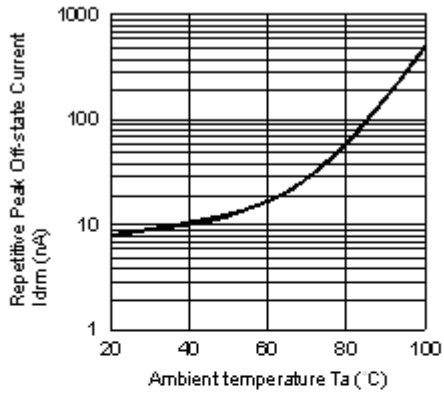
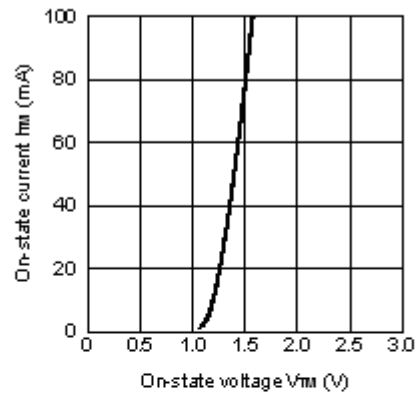
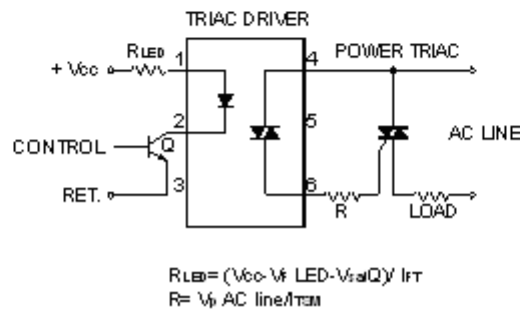

Fig. 8 On-state Current vs. On-state Voltage



### Basic Driver Circuit





# Photocoupler MOC308X series

## 6. TEMPERATURE PROFILE OF SOLDERING

### 6.1 IR Reflow soldering (JEDEC-STD-020C compliant)

One time soldering reflow is recommended within the condition of temperature and time profile shown below. Do not solder more than three times.

Profile item	Conditions
Preheat	
- Temperature Min ( $T_{Smin}$ )	150°C
- Temperature Max ( $T_{Smax}$ )	200°C
- Time (min to max) (ts)	90±30 sec
Soldering zone	
- Temperature ( $T_L$ )	217°C
- Time ( $t_L$ )	60 sec
Peak Temperature ( $T_P$ )	260°C
Ramp-up rate	3°C / sec max.
Ramp-down rate	3~6°C / sec

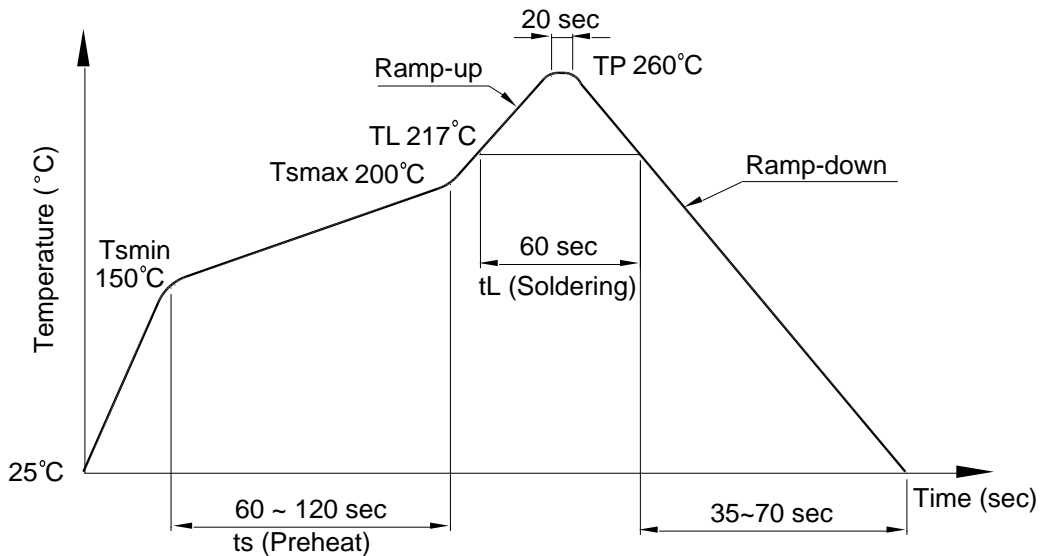

**Photocoupler  
MOC308X series**

**6.2 Wave soldering (JEDEC22A111 compliant)**

One time soldering is recommended within the condition of temperature.

Temperature:  $260 \pm 0 / -5^{\circ}\text{C}$

Time: 10 sec.

Preheat temperature: 25 to  $140^{\circ}\text{C}$

Preheat time: 30 to 80 sec.

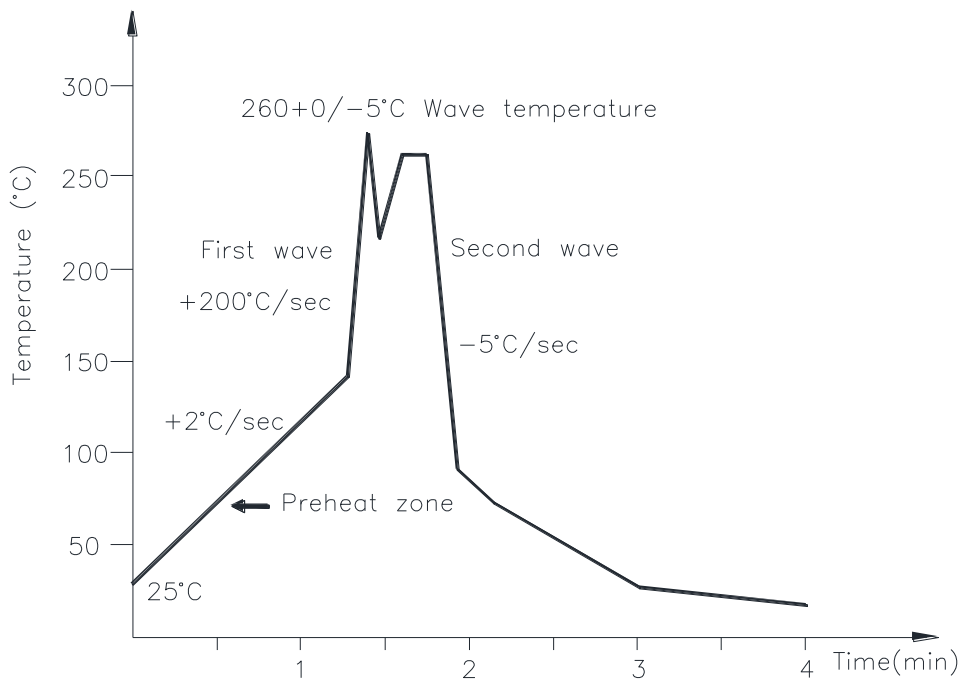

**6.3 Hand soldering by soldering iron**

Allow single lead soldering in every single process. One time soldering is recommended.

Temperature:  $380 \pm 0 / -5^{\circ}\text{C}$

Time: 3 sec max.

**Photocoupler  
MOC308X series**

**7. RRECOMMENDED FOOT PRINT PATTERNS (MOUNT PAD)**

Unit: mm

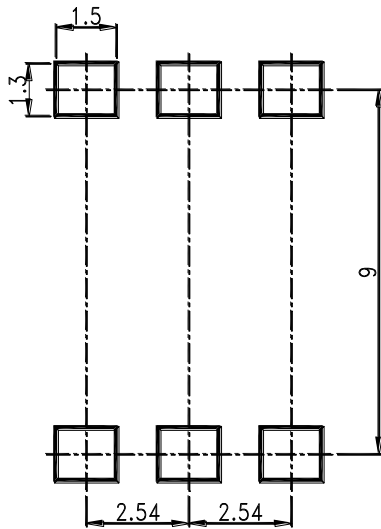

**Photocoupler  
MOC308X series**

**8. NAMING RULE**

# MOC308(X)(1)-(2)

DEVICE PART NUMBER (MOC308X)

Please refer to Electrical Optical Characteristics Table on Page P5

(1) FORM TYPE (S, M or none)

(2) TAPING TYPE (TA, TA1)

Example : MOC3081S-TA1

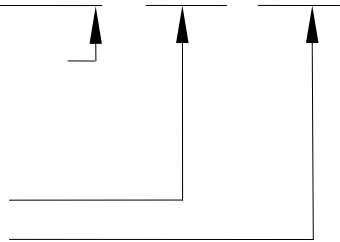

# MOC308(X)(1)(2)-V

DEVICE PART NUMBER (MOC308X)

Please refer to Electrical Optical Characteristics Table on Page P5

(1) FORM TYPE (S, M or none)

(2) TAPING TYPE (TA, TA1)

(3) VDE option

Example : MOC3081STA1-V

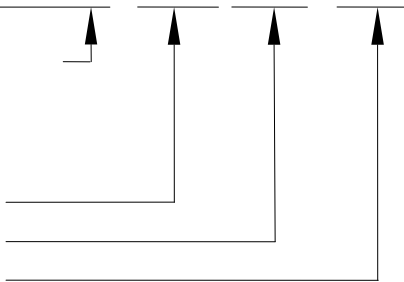

**9. NOTES**

- LiteOn is continually improving the quality, reliability, function or design and LiteOn reserves the right to make changes without further notices.
- The products shown in this publication are designed for the general use in electronic applications such as office automation equipment, communications devices, audio/visual equipment, electrical application and instrumentation.
- For equipment/devices where high reliability or safety is required, such as space applications, nuclear power control equipment, medical equipment, etc, please contact our sales representatives.
- When requiring a device for any "specific" application, please contact our sales in advice.
- If there are any questions about the contents of this publication, please contact us at your convenience.
- The contents described herein are subject to change without prior notice.
- Immerge unit's body in solder paste is not recommended.