

Paladin *PL18 EV*



Quick Start Guide

Precautions!

For your own safety: make sure to download and read the Disclaimer & Warning documentation from the Flysky website before using this product.

Flysky Website : www.flysky-cn.com

1. For best signal quality the transmitters antenna must be kept at least 20 cm away from all your body and must not be juxtaposed or operated close to other transmitters. Antenna installation instructions and transmitter operating conditions that meet RF signal emissions must be provided to end users and installers.
2. Hereby, [Flysky Technology co., Ltd] declares the RF equipment [Paladin PL18 EV] to be in accordance with RED2014/53/EU.
3. The full text of the EU DoC is available at: www.flysky-cn.com.

Front View

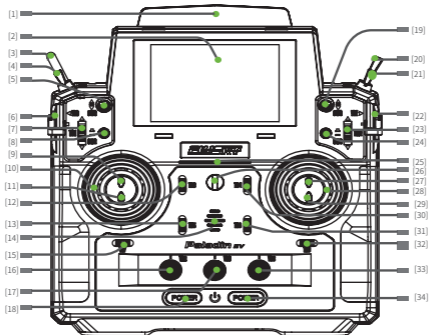

[1]	Antenna	[11]	SW1 Button	[21]	SWG 2 Position Switch
[2]	320*480px Screen	[12]	TR3 Button	[22]	VRE Knob
[3]	SWF 2 Position Switch	[13]	TR5 Trim	[23]	TR2 Button
[4]	SWE 3 position switch	[14]	Speaker	[24]	SWC Button
[5]	SWB 3 Position Switch	[15]	TR7 Trim	[25]	Transmitter Status Indicator
[6]	VRD Knob	[16]	VRA Knob	[26]	Lanyard Eye
[7]	TR1 Button	[17]	VRB Knob	[27]	SWL Button
[8]	SWA Button	[18]	Power Button	[28]	Right Gimbal
[9]	SWJ Button	[19]	SWD 3 Position Switch	[29]	SWK Button
[10]	Left Gimbal	[20]	SWH 2 Position Switch with Self-return	[30]	TR4 Button

Back View

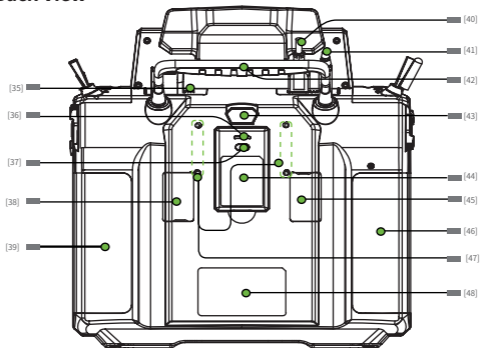

[31]	TR6 Trim	[40]	Micro USB Port
[32]	TR8 Trim	[41]	Trainer Port
[33]	VRC Knob	[42]	Grip
[34]	Power Button	[43]	FRM301 Press to release FRM301
[35]	Bluetooth Module Port	[44]	FRM301 RF Module
[36]	FRM301 Status Indicator	[45]	Gimbal Tension Adjustment
[37]	FRM301 Button	[46]	Grip
[38]	Gimble Tension Adjustment	[47]	RF Module Port
[39]	Grip	[48]	Wireless Charging Area

- For more information about the Paladin EV transmitter please read the user manual.

Power On

1. Check to make sure that the battery is fully charged;
2. Press both power buttons to turn on the transmitter.



If any switches are not at their highest positions, the system will prompt: “Switch is not in the highest position” . The transmitter will show which switches are not in the correct position by highlighting them in red on a diagram.

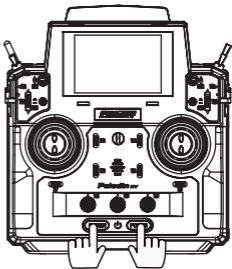

Power Off

1. Power off the receiver.
2. Press and hold both power buttons until the screen turns off. After powering off the transmitter wait for 3 seconds before turning it on again.







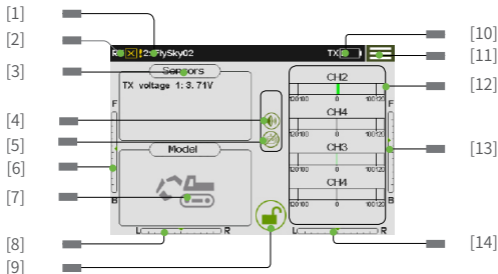



Always power off the receiver before the transmitter. Powering off the transmitter before the receiver may lead to loss of control of the model.

Main Screen Introduction



- | | |
|-----------------------------|----------------------------------|
| [1] Model Name | [8] Left Stick Left/Right Trim |
| [2] Rx Signal | [9] Lock/Unlock |
| [3] Sensor | [10] Transmitter Power |
| [4] Voice | [11] Function Menu Icon |
| [5] vibration | [12] Channels Display |
| [6] Left Stick Up/Down Trim | [13] Right Stick Up/Down Trim |
| [7] Model Type | [14] Right Stick Left/Right Trim |

	Indicates that the screen is locked		Indicates that the screen is unlocked
	Function Disabled		Function Enabled
	Touch to restore functions default settings		Touch to enter function menu
	Click to assign controls such as switches		Click to set the curve type

Gimbal Adjustment Instructions

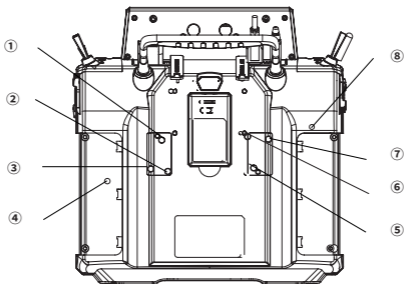

Function Setup

By adjusting the tension screws on the back of the radio, gimbal stick can be either self-centering or non self-centering, as well as changing stick tension preference.

Available option

① . ⑤	left & right side gimbal sticks automatic self centering	② . ⑥	left & right side gimbal stick vertical tension
③ . ⑦	left & right side gimbal stick horizontal tension	④ . ⑧	throttle stick vertical friction

Left gimbal as example

Non Self-returning

1. Use a Phillips screwdriver to adjust the screw
① counterclockwise until the gimbal reaches its center point.
2. Adjust screw ④ counterclockwise to adjust the Frictional strength.
3. If you need to adjust the strength of the return, adjust screw ② to the middle, and strengthen the clockwise force, and vice versa as needed.

Self-return and Non self-return

1. Use a Phillips screwdriver to adjust the screw ① clockwise so that the gimbal is no longer at its center point.
2. Adjust the screw ④ clockwise to strengthen or reduce the Frictional strength..
3. If you need to adjust the strength of the return, adjust screw ② to the middle, and strengthen the clockwise force, and vice versa as needed.



Attention

When the counterclockwise adjustment is made, entire range of movement of the screw is about 3mm. Be cautious not to adjust it too far or the screw will fall out.

Charging Modes

PL18EV can be charged in two ways:

1. Plug the standard USB cable into the charging port for charging
2. Use the wireless charging dock to charge it (as shown in the figure)

Notes:

- Please charge it within a safe value, (6h@5V Micro USB /7h@2A Wireless Charging) because overcharging may cause damage to the battery;
- To prolong the service life of the battery, properly discharge the fully charged battery before long-term storage, and charge it regularly to prevent over-discharging damage during storage;
- Please use the standard charging head of this receiver to charge it. Improper use may cause damage to the battery and affect its service life.

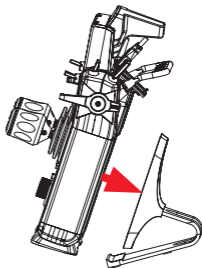



Language

This transmitter has 2 languages available:



Function Setup

Touch the function menu icon  to enter the function menu, touch [System Settings], then touch [Language Selection]. Touch your preferred language option and touch the back icon  to save and exit.

RF Module Update

If the following prompt is displayed on start up, the RF module needs to be updated.



Touch “yes” to enter update mode. Touch “no” to exit the update menu. If the RF module requires and update complete the following steps:

How To Update

Touch the function menu icon  to enter the function menu, touch [RF setup], then [RF firmware update]. When prompted touch yes to start the update. Once the update is completed the system will go back to the previous menu.

Binding

The transmitter and receiver have been pre-bound at the factory, however if you need to bind a new receiver or rebind the original receiver follow the steps below.

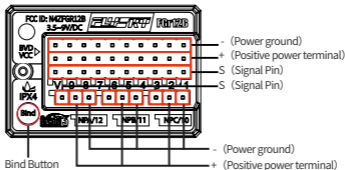

1. Press and hold the receiver BIND button while powering on the receiver, release the BIND button after receiver is powered on, the LED on the receiver will flash rapidly.
2. Power on the transmitter, Touch the Function Menu Icon  and enter the Function Menu, Choose [RX setup] then click [Bind with a receiver].
3. the receiver LED stops flashing and is on continuously, the binding process is complete.
4. Check to make sure the transmitter and receiver functions are working correctly, repeat steps 1 to 3 (binding process) if any problems arise.



If after a firmware update is performed and the transmitter is unable to bind to the receiver, the receiver may need to be put into forced update times.

1. Power on the receiver while pressing the BIND button approximately ten seconds until the LED flashes three times, release the BIND button.
2. Go to the [RX Setup] menu on your transmitter and select [RX Update].
3. When the receiver LED flashes slowly, the update is successful.

The above steps are only applicable when pairing the Paladin EV with FGr12B and FGr8B, If you are using other receivers, please refer to the receivers user manual.

Failsafe Function

This function protects the user by preventing the model from behaving unexpectedly if signal is lost.

All 18 channels are displayed failsafe menu. If set to [OFF], the channel will remain at its last set position before losing signal.

If a percentage is displayed, then that channel will move to that percentage when signal is lost. Failsafe is active by default.

Failsafe Time: Sets how long it takes for the failsafe settings to kick in after signal loss.

Function Settings

Touch the function menu icon  to enter the function menu, touch [Rx Setup], touch [Failsafe]. Touch the icon at the bottom middle of the screen to turn failsafe on or off globally.

Failsafe Setup

Touch a channel to enter its failsafe menu. Move the stick, button, knob or switch to the desired failsafe position and touch the back button  to save and exit.

- When the  icon is displayed on a channel or in the global function bar the function is disabled for that channel or globally.
- The failsafe function needs to enter the [Auxiliary Channel] function to assign controls to aux channels before these channels can be used.

Specifications

Paladin (PL18 EV)

Product Name	PL18 EV
Channels	18
RF	2.4GHz
Transmission Power	< 20dBm (EU)
2.4GHz Protocol	AFHDS 3
Low Voltage Alarm	< 3.65V
Data Port	USB、 Non-standard interface (USART) 、 PHJACK (PPM)
Charging Port	Micro USB、 wireless charging
Antenna Type	Dual Antenna
Input Power	1S (3.7V) *4300mAh
Input Time	6h@5V Micro USB/7h@2A Wireless Charging
Online Update	Yes
Dimensions	120*195*213mm
Weight	1012g
Certification	CE, FCC ID: N4ZFT1800

注意事项！

开始操作前请务必在 Flysky 官网下载并阅读《免责声明 & 警告》了解安全注意事项，并在 Flysky 官网下载阅读使用说明书。

Flysky 官网地址：www.flysky-cn.com

1. 发射机的天线必须距离所有人员或其他发射机至少 20 厘米的间隔距离。必须将天线安装说明和满足射频讯号辐射的发射机操作条件提供给终端用户和安装人员。
2. 特此,【Flysky Technology co., Ltd】声明无线电设备【Paladin(PL18 EV),FT18 EV】符合 RED2014/53/EU.
3. 欧盟 DoC 声明全文可在以下互联网地址：www.flysky-cn.com 获取。

前视图:

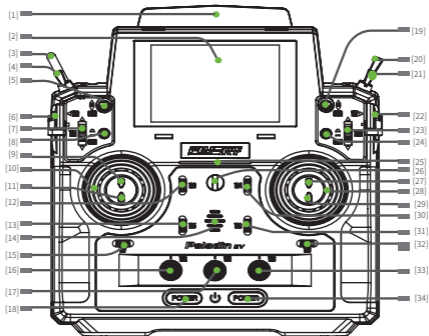

[1]	天线	[11]	SWI 按键	[21]	SWG 两档开关
[2]	320 * 480dots 显示屏	[12]	TR3 按键	[22]	VRE 拨杆
[3]	SWF 两档开关	[13]	TR5 微调按键	[23]	TR2 按键
[4]	SWE 三档开关	[14]	喇叭	[24]	SWC 按键
[5]	SWB 三档开关	[15]	TR7 微调按键	[25]	发射机状态指示灯
[6]	VRD 拨杆	[16]	VRA 旋钮	[26]	吊环
[7]	TR1 按键	[17]	VRB 旋钮	[27]	SWL 按键
[8]	SWA 按键	[18]	电源键	[28]	右摇杆
[9]	SWJ 按键	[19]	SWD 三档开关	[29]	SWK 按键
[10]	左摇杆	[20]	SWH 两档复位开关	[30]	TR4 按键

后视图:

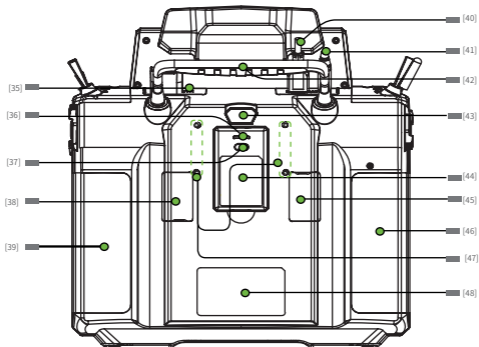

- | | | | |
|------|------------|------|--------------|
| [31] | TR6 微调按键 | [40] | Micro USB 接口 |
| [32] | TR8 微调按键 | [41] | 教练接口 |
| [33] | VRC 旋钮 | [42] | 提手 |
| [34] | 电源键 | [43] | 按压弹出 FRM301 |
| [35] | 蓝牙模块接口 | [44] | 高频模块 FRM301 |
| [36] | FRM301 指示灯 | [45] | 总成座松紧度调节 |
| [37] | FRM301 按键 | [46] | 手胶 |
| [38] | 总成座松紧度调节 | [47] | 高频头转接件固定孔 |
| [39] | 手胶 | [48] | 无线充电感应区 |

● 关于 Paladin EV 发射机的更多操作请阅读使用说明书。

开机

1. 检查系统状态，确保：
电池电量充足；
2. 同时按住发射机两个电源键开机。

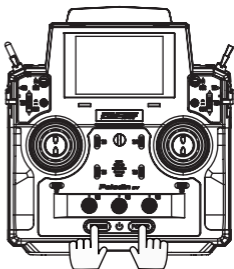

开机警告！

当开机语音提示“开关不在高位”或“Switch is not in the highest position”同时发射机弹出提示界面时（红色表示对应控件位置需调整），请根据提示检查按键，开关，并按照发射机提示将其放在正确位置。

当开机语音提示“开关不在高位”或“Switch is not in the highest position”同时发射机弹出提示界面时（红色表示对应控件位置需调整），请根据提示检查按键，开关，并按照发射机提示将其放在正确位置。

关机

1. 断开接收机电源；
2. 同时长按发射机两个电源键，直至屏幕熄灭，表示关机。

发射机屏幕熄灭后，需等待 3s 后，方可完全关闭，期间请勿再次开机。



关闭前，请务必先断开接收机电源，然后关闭发射机。如果强行关闭发射机，将有可能导致遥控设备失控或者引擎继续工作而引发事故。

主界面介绍

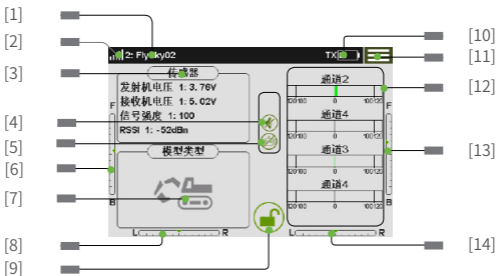

- | | |
|-------------|--------------|
| [1] 模型名称 | [8] 左摇杆左右微调 |
| [2] 接收机信号 | [9] 解 / 上锁键 |
| [3] 传感器 | [10] 发射机电量 |
| [4] 声音 | [11] 功能菜单 |
| [5] 振动 | [12] 通道显示 |
| [6] 左摇杆上下微调 | [13] 右摇杆上下微调 |
| [7] 模型类型 | [14] 右摇杆左右微调 |

	表示功能或此界面被锁定不可操作		表示此功能或此界面可操作
	表示此功能在禁用状态		表示此功能在开启状态
	点击可使功能恢复初始值		点击可对功能进行设置
	点击可进行开关等控件分配		点击可进行曲线类型设置

总成座调节说明

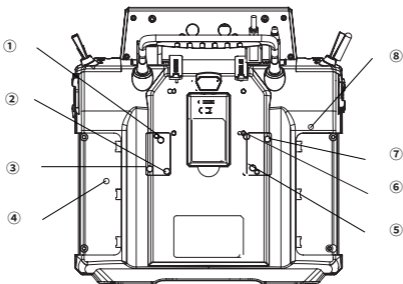

功能设置

用户可调节螺丝孔螺丝实现总成座回中与不回中切换、调节摇杆弹力，请参照以下步骤：

螺丝说明

① . ⑤	调节总成座摇杆是否回中	② . ⑥	调节总成座纵向摇杆弹力
③ . ⑦	调节总成座横向摇杆弹力	④ . ⑧	调节总成座纵向摇杆摩擦力

以右边摇杆为例

不回中 - 回中

1. 请用十字螺丝刀逆时针调节①号螺丝使摇杆变为回中状态；
2. 逆时针调节④号螺丝调整摩擦力度；
3. 如还需调整回中力度，请操作②号螺丝调节回中力度，顺时针力度加强，反之减弱。

回中 - 不回中

1. 请用十字螺丝刀顺时针调节①号螺丝使摇杆为不回中状态；
2. 顺时针调节④号螺丝加强摩擦力度；
3. 如还需调整回中力度，请操作②号螺丝调节回中力度，顺时针力度加强，反之减弱。



注意

逆时针调节时行程为 3mm 左右，需凭手感调节力度，否则螺丝会脱落。

充电方式

PL18EV 可通过两种方式对其进行充电：

1. 标准 USB 线插入充电口充电
2. 使用无线充电底座对其进行充电
(如图所示)

注：

- 请在安全值内 (6h@5V Micro USB/7h@2A 无线充) 对其进行充电，过充可能会导致电池损坏；
- 为延长电池使用寿命，长时间放置请注意不要满电，应适当放电后再进行放置，并且应定期充电防止电池过放损坏；
- 请使用本款接收机标配的充电头对其进行充电，使用不当可能造成电池损坏影响使用寿命。

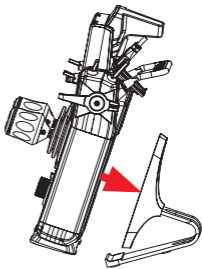

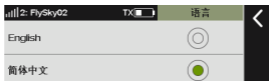

语言

本发射机可使用两种语言：



功能设置：

点击主界面  图标，进入功能菜单界面，选择进入 [系统设置] 功能，点击 [语言选择]，进入设置界面，可根据需要选择语言，设置完成后，点击返回 ，保存设置并退出。

高频模块固件升级

当开机时弹出如下提示，则需要更新高频模块。

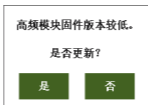

点击“是”，进入更新状态，点击“否”，退出更新界面，此时如需升级高频头，请参照以下步骤：

更新步骤：

点击主界面  图标，进入功能菜单界面，选择进入 [高频设置] 功能，点击 [高频模块固件升级]，在弹出提示后，点击 [是]，更新完成后，自动退出更新界面。

对码

本发射机和接收机在出厂前已对码成功。如果您需要对码时，请按照如下步骤进行对码：

1. 按住接收机对码按钮同时上电，松开对码按钮，接收机指示灯快闪；
2. 开启发射机，点击主界面  图标进入功能菜单后，选择进入 [接收机设置]，点击 [接收机对码]；
3. 对码成功后，接收机指示变为常亮；
4. 检查舵机是否正常工作。如需重新对码，请重复以上步骤。

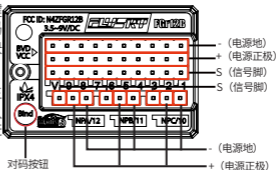

! 发射机在更新完后，如无法与接收机对码，需强制更新接收机。具体步骤如下：

1. 接收机按下对码按钮，上电十秒钟后指示灯三闪一灭，松开对码按钮；
2. 在发射机端点击 [接收机设置]，选择 [接收机固件更新]，在选择对应的接收机后点击 [升级]，即可完成更新。
3. 更新完成指示灯慢闪。

以上步骤适用于 Paladin EV 与 FGr8B 和 FGr12B 的接收机对码，如您使用的是其他接收机，请进入官网查询。

失控保护

该功能用于在接收机丢失信号或失控后，保护模型和操作人员的安全。

失控保护菜单下显示 18 个通道的列表，如果在通道后显示 [关闭]，表示模型在丢失信号后，该通道的舵机会继续保持失控前的位置继续行驶。如果显示一个百分比，则表示模型在丢失信号后，该通道的舵机会移动到百分比对应的位置，并保持在该位置继续行驶。

触发时间：可设置失控生效的时间。

功能设置：

点击主界面  图标，进入功能菜单界面，选择进入 [接收机设置] 功能，点击 [失控保护]，进入设置界面，可根据需要进行失控保护的设置。

保护值设置方法：

点击选择所需设置通道，将通道对应控件（摇杆、按键、开关、滑杆）移动至所需位置保持不动，点击返回 ，保存设置并退出。

- 当对应通道界面显示  图标时，表示该功能处于关闭状态，设置无效。
- 失控保护功能需进入 [辅助通道] 功能为通道分配控件后，方可进行对应通道的失控保护设置。

规格参数

Paladin (PL18 EV)

产品型号	PL18 EV
通道个数	18
无线频率	2.4GHz
发射功率	< 20dBm
无线协议	AFHDS 3
低电压报警	< 3.65 V
数据接口	USB、Non-standard interface (USART) 、 PHJACK (PPM)
充电接口	Micro USB/ 无线充
天线类型	双天线
电池	1S (3.7V) *4300mAh (内置)
充电时间	6h@5V Micro USB/7h@2A 无线充
在线更新	Yes
外形尺寸	120*195*213 mm
机身重量	1012g
认证	CE, FCC ID: N4ZFT1800



FCC ID: N4ZFT1800

出版日期 :2020-08-17

Copyright ©2020 Flysky Technology co., ltd

