

# BIGTREE TECH MANTA M8P V1.0&V1.1 User Manual

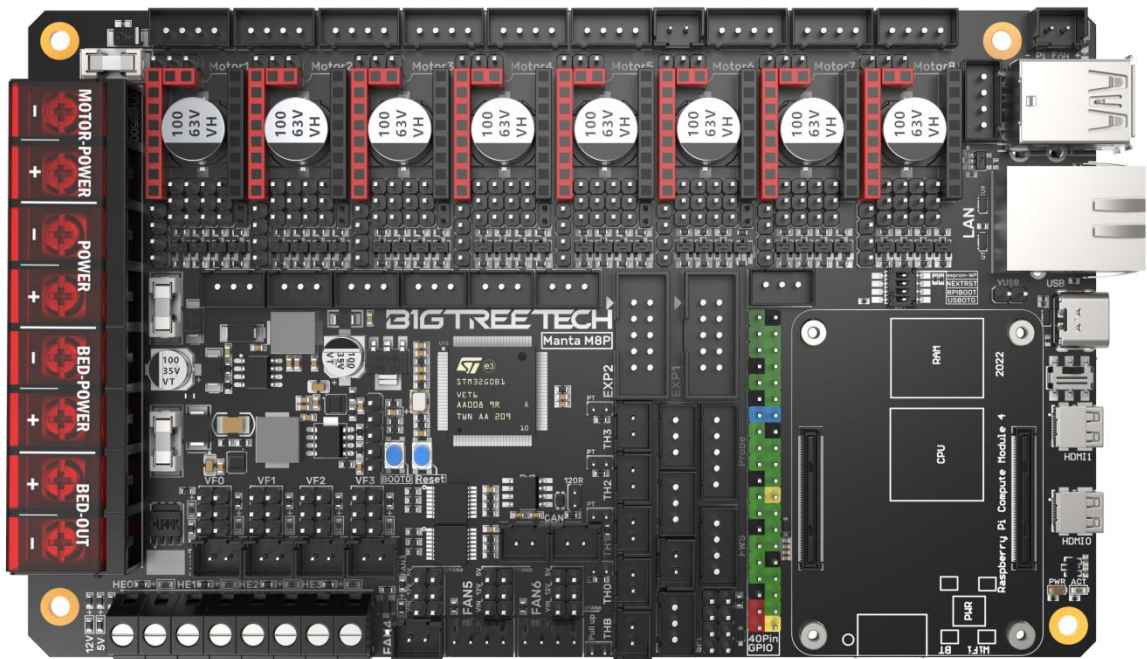

## Contents

<b>Contents</b> .....	2
<b>Revision History</b> .....	5
<b>1 Brief Introduction</b> .....	6
1.1 Main Features.....	6
1.2 Basic Parameters.....	7
1.3 Product Dimension.....	9
<b>2 Peripheral Interface</b> .....	10
2.1 Interface Diagram.....	10
2.2 Pin-out.....	10
<b>3 Interface Instruction</b> .....	13
3.1 USB Power Supply.....	13
3.2 Stepper Motor Drive.....	13
3.2.1 Normal STEP/DIR(STANDALONE) Mode.....	13
3.2.2 UART Mode of TMC Driver.....	14
3.2.3 SPI Mode of TMC Driver.....	15
3.2.4 DIAG(Sensorless Homing) of TMC Driver.....	15
3.2.5 Selection of driving power supply for stepping motor.....	15
3.3 Installing the Core Board.....	16
3.4 Voltage Selection of CNC Fans.....	17
3.5 100K NTC or PT1000 Setting.....	17
3.6 BLTouch Wiring.....	18
3.7 Auto Shutdown Module(Relay V1.2) Wiring.....	18
3.8 EXP1+EXP2 and LCD Screen Wiring.....	19
3.9 RGB Wiring.....	19
3.10 Filament Runout Detection Wiring.....	20
3.11 40 Pin GPIO.....	20
3.12 DSI/CSI Connection.....	21

3.13 Proximity Switch Wiring.....	21
3.14 Wiring of the 4-wire CNC Fan and the Water Cooling Device(12V as an example, as shown in the following figure: ).....	22
4. Raspberry PI CM4 Setup steps.....	24
4.1 Download OS Image.....	24
4.2 Download and Install Raspberry Pi Imager.....	24
4.3 Write OS Image.....	25
4.3.1 CM4 LITE Version (Micro SD Card).....	25
4.3.2 CM4 eMMC Version(Note: eMMC version will not tun the system from the Micro SD card.).....	28
4.4. System Settings (CM4).....	28
4.4.1 USB 2.0 Hub Ports.....	28
4.4.2 DSI1 Display Interface.....	29
4.4.3 CSI1 Camera.....	29
5. BIGTREETECH CB1 Setup steps.....	29
5.1 Download OS Image.....	29
5.2 Download and Install Raspberry Pi Imager.....	30
5.3 Write OS Image.....	30
5.4 WIFI Setting.....	32
5.5 Install Klipper with kiah Script.....	32
5.6 Checkout Klipper Branch.....	错误！未定义书签。
5.7 Fix KlipperScreen.....	错误！未定义书签。
6. Configure the motherboard.....	33
6.1 ssh connect to device.....	33
6.2 Compile firmware.....	36
6.3 Firmware update.....	37
6.3.1 Update using SD Card.....	37
6.3.2 Update using DFU.....	37
6.4 Configure Klipper.....	38

Shenzhen Big Tree Technology Co., Ltd.  
**BIGTREETECH**

---

7 Differences between V1.0 and V1.1.....	11
8 Precautions.....	39

## Revision History

Revision	Description	Date
01.00	First Draft	2022/06/18
01.01	Delete 31865	2022/08/04
01.02	Added an introduction to V1.1	2022/09/30
01.03	Added ADXL345 wiring diagram	2022/12/22
01.04	Fix wrong ADXL345 CS	2023/01/09

## 1 Brief Introduction

BIGTREETECH MANTA M8P is a 32-bit printer motherboard developed by the 3D printing team of Shenzhen Big Tree Technology Co., Ltd. for Klipper firmware. You can simply plug in the core board to run the Klipper firmware, which greatly simplifies the connection between the motherboard and the Raspberry Pi, and saves a lot of space. Moreover, the BTB connector is designed to install CM4 or other solutions to solve the current expensive problem of CM4.

### 1.1 Main Features

1. Adopt 32-bit 64MHz ARM Cortex-M0+ series STM32G0B1VET6 as the main control chip;
2. The power chip, TPS5450-5A, supports DC12/24V power input. The output current of the chip is up to 5A, and the peak value can reach 6A, which perfectly supports the power supply of Raspberry Pi;
3. There is a BOOT button reserved on the motherboard, users can update the bootloader through DFU;
4. The thermistor part includes a protection circuit that protects the main control chip from the possibility of burning caused by leakage of the heated bed or heater cartridge;
5. 24V, 12V, and 5V voltages are available for CNC fans, eliminating the need for an external transformer module, thereby reducing the chance of damage to the motherboard due to improper operation;
6. The thermistor can select the pull-up resistor value through the jumper, in this way, it supports PT1000 without an external module, which is convenient for customers to DIY;
7. The MCU firmware can be updated via an SD card, or through Klipper's make flash command using DFU;
8. The motherboard and the core board use the BTB connection to allow using other solutions other than CM4;
9. On-board TMC-driver SPI and UART working modes, on-board DIAG function pins, can be used by simply plugging and unplugging the jumper cap;
10. Support filament runout detection, auto shutdown, BLTouch, RGB lights...
11. High efficiency MOSFET for less heat generation;
12. Adopt replaceable fuse for easy replacement;

13. Three-way four-wire fan interface is reserved, and can be used to connect the water cooling device;
14. The proximity switch interface is reserved, supports NPN and PNP types, (24V, 12V, 5V) voltage selection is available, common voltage selection with VFAN6;
15. Provide the SPI expansion interface to allow Klipper firmware users to connect an external acceleration sensor for acceleration compensation.

## 1.2 Basic Parameters

1. Product Size: 170 x 102.7mm, you can read more details here **BIGTREETECH MANTA M8P V1.0-SIZE-top.pdf**
2. Installation Size: Please read: **BIGTREETECH MANTA M8P V1.0-SIZE-top.pdf**
3. Microprocessor: ARM Cortex-M0+ STM32G0B1VET6 64MHz
4. Drive Input Voltage: VIN (12V/24V) Or HV( $\leq 56V$ )
5. Motherboard Input Voltage: VIN=DC12V or DC24V
6. Heated Bed Input Voltage: BED IN=DC12V or DC24V
7. Logic Voltage: DC3.3V
8. Heating Port: Heated Bed(HB), Heater Cartridge(HE0, HE1, HE2, HE3)
9. The maximum output current of the heated bed port: 10A, Peak Value: 12A
10. The maximum output current of the heater cartridge port: 5.5A, Peak Value: 6A
11. Fan Port: Two-wire CNC Fan (FAN0, FAN1, FAN2, FAN3), four-wire CNC Fan fan (FAN4, FAN5, FAN6), Always-on Fan (24V FAN x 2), among which the CNC Fan voltages are 5V, 12V, 24V optional
12. The maximum output current of the fan port: 1A, Peak Value: 1.5A
13. Total current for heater cartridge + driver + fan:  $< 12A$
14. Extended Interface: BLTouch(Servos, Probe), PS-ON, Fil-DET, RGBx2, SPI
15. Motor Driver: Support TMC5160, TMC2209, TMC2225, TMC2226, TMC2208, TMC2130, ST820, LV8729, DRV8825, A4988...
16. Driver Working Mode Support: SPI, UART, STEP/DIR

17. Motor Drive Interface: Motor1, Motor2, Motor3(dual motor interface), Motor4, Motor5, Motor6, Motor7, Motor8, a total of Eight
18. Temperature Sensor Interface: 5-way 100K NTC, of which 4-way 100K NTC and PT1000 are optional
19. Support Screen: SPI Touch Screen, LCD Screen
20. PC Communication Interface: Type-C
21. Functional Interface: USB 2.0 x 3, LAN, DSI, CSI, SPI, 40Pin-GPIO, HDMI0 and HDMI1, SOC-Card, MCU-Card
22. Support Machine Structure: Cartesian, Delta, Kossel, Ultimaker, CoreXY
23. Recommended Software: Cura, Simplify3D, Pronterface, Repetier-host, Makerware





## 2 Peripheral Interface

### 2.1 Interface Diagram

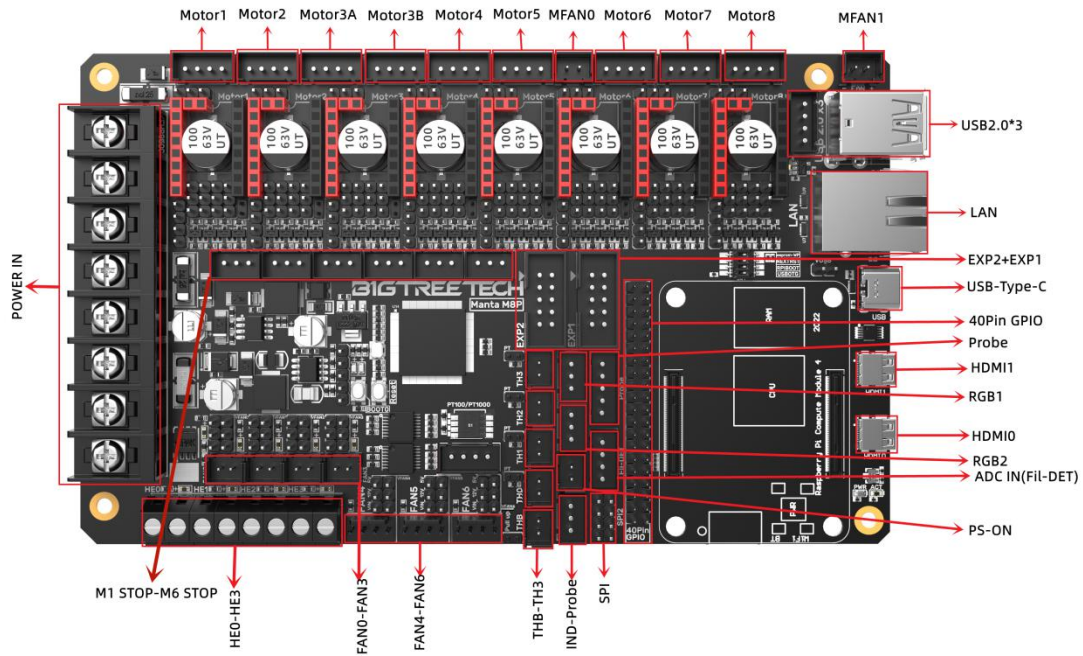

### 2.2 Pin-out

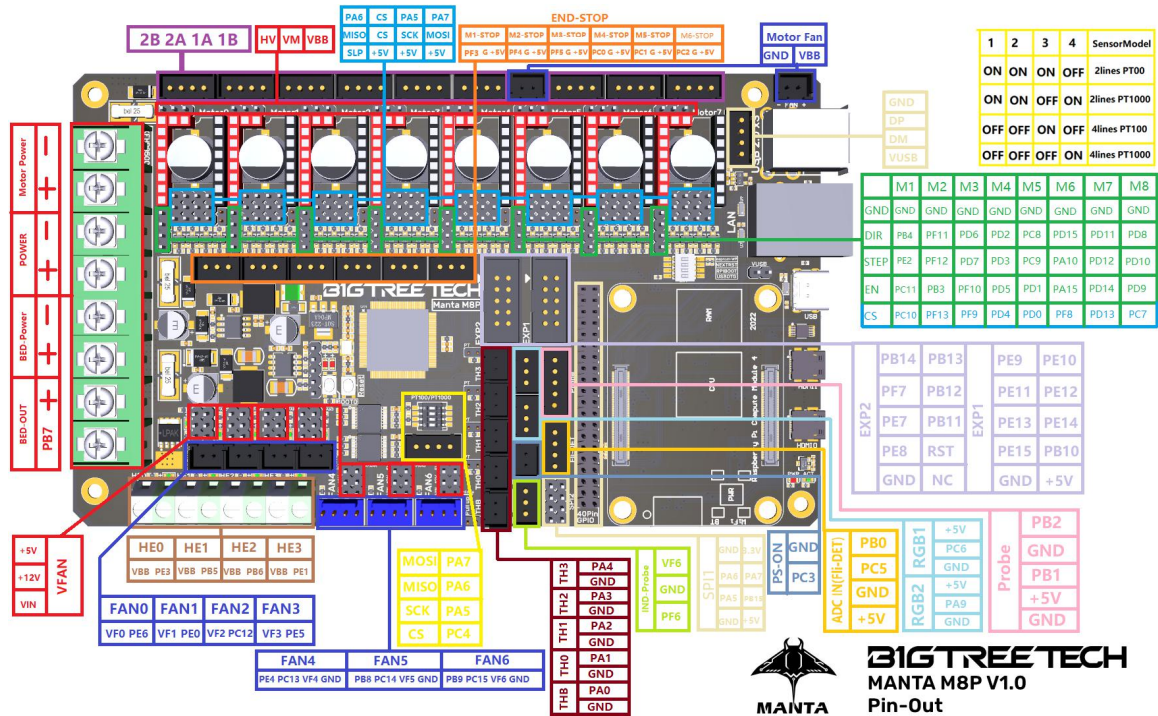

**BIGTREE TECH**  
**MANTA M8P V1.0**  
**Pin-Out**



Shenzhen Big Tree Technology Co., Ltd.  
**BIGTREE TECH**

M8P V1.1+CB1:

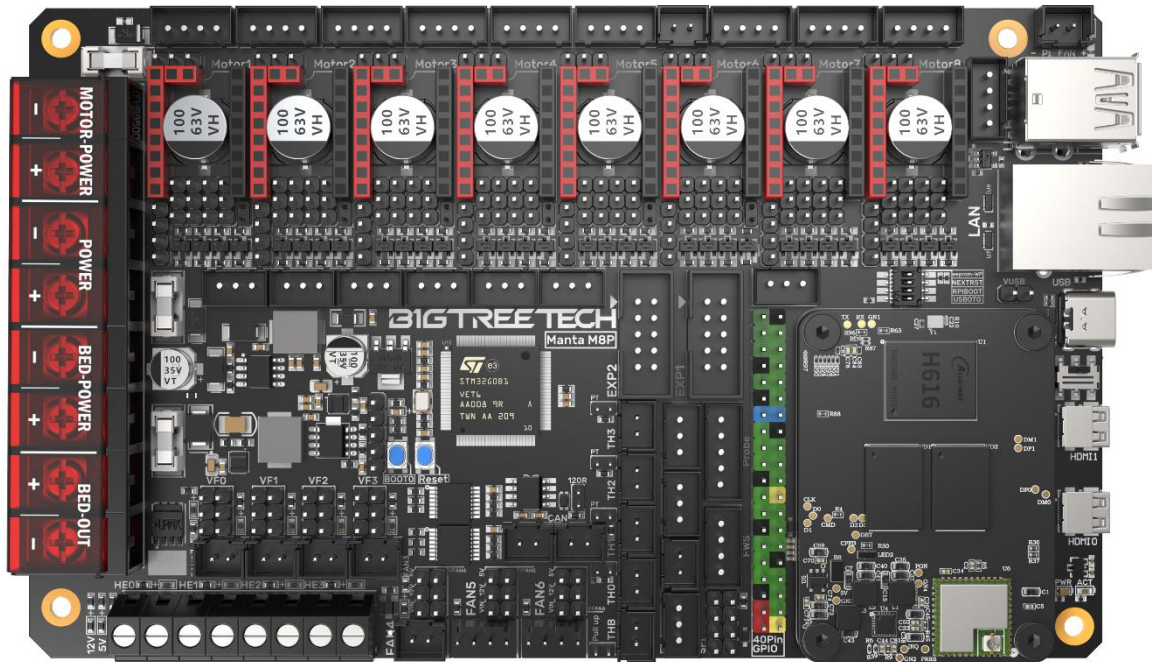

M8P V1.1-Bot:

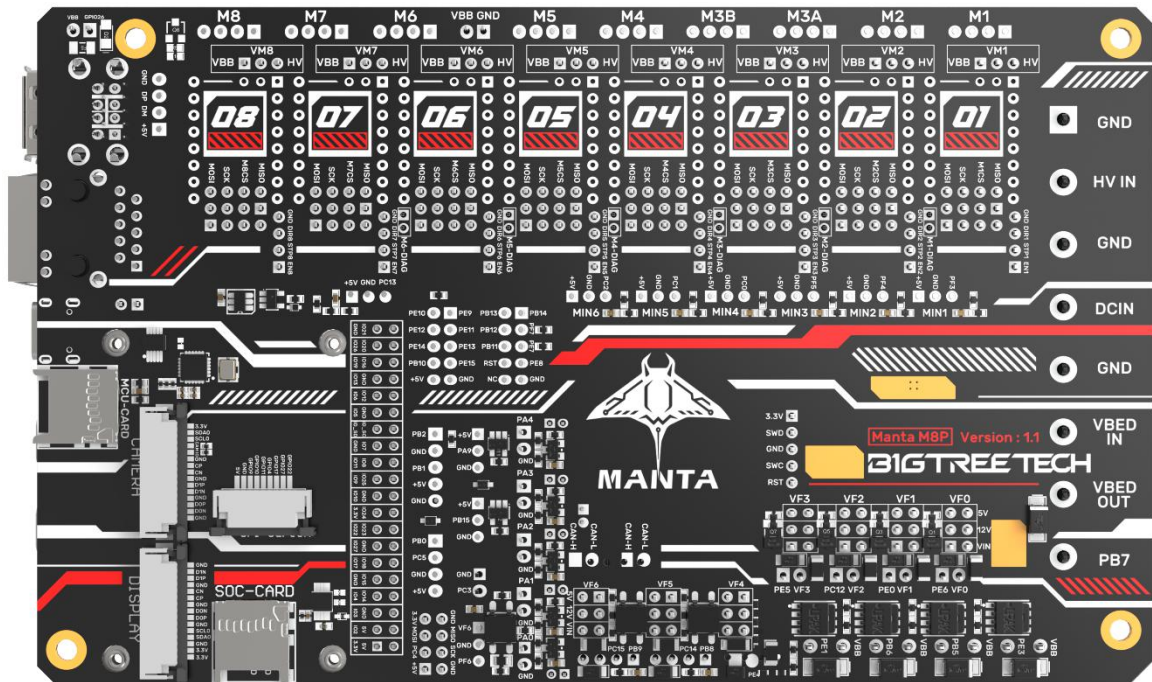

### 3 Interface Instruction

#### 3.1 USB Power Supply

After the M8P motherboard is powered on, the D32 red light on the left side of the MCU will light up, indicating that the power supply is normal. The VUSB in the middle of the board is the power selection terminal. Only when using USB to supply power to the motherboard or need to supply power through USB, do you need to use the jumper to short it.

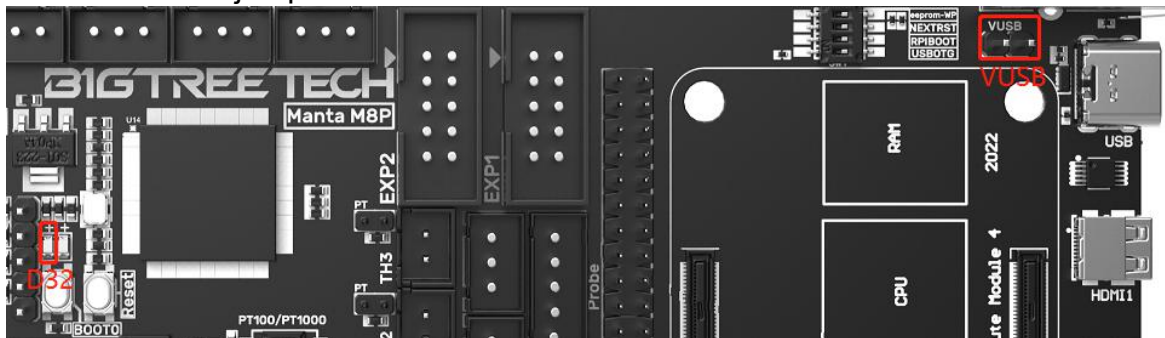

#### 3.2 Stepper Motor Drive

##### 3.2.1 Normal STEP/DIR(STANDALONE) Mode

For example, A4988, DRV8825, LV8729, ST820...use the jumper cap to short MS0-MS2 according to the driver subdivision table.

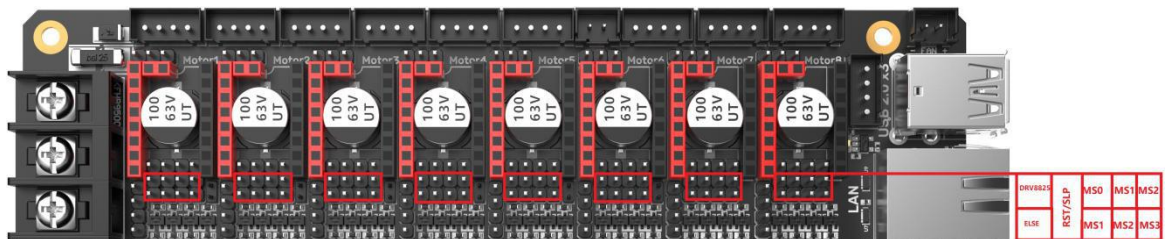

**Note:** If using A4988 or DRV8825, RST and SLP must be shorted with jumper caps for normal operation.

Driver Chip	MS1	MS2	MS3	Subdivision	Excitation Mode
A4988 Max 16 Subdivisions 35V 2A	L	L	L	Full Step	2 Phase
	H	L	L	1/2	1-2 Phase
	L	H	L	1/4	W1-2 Phase
	H	H	L	1/8	2W1-2 Phase
	H	H	H	1/16	4W1-2 Phase
Driving Current Calculation Formula $R_S=0.1\Omega$	$I_{TripMAX} = \frac{V_{REF}}{8 * R_S}$				

Driver Chip	MD3	MD2	MD1	Subdivis	Excitation Mode
-------------	-----	-----	-----	----------	-----------------

				ion	
LV8729 Max 128 Subdivisions 36V 1.8A	L	L	L	Full Step	2 Phase
	L	L	H	1/2	1-2 Phase
	L	H	L	1/4	W1-2 Phase
	L	H	H	1/8	2W1-2 Phase
	H	L	L	1/16	4W1-2 Phase
	H	L	H	1/32	8W1-2 Phase
	H	H	L	1/64	16W1-2 Phase
	H	H	H	1/128	32W1-2 Phase
Driving Current Calculation Formula RF1=0.22Ω	$I_{OUT} = (V_{REF} / 5) / RF1$				

Driver Chip	MS3	MS2	MS1	Subdivision
ST820 Max 256 Subdivisions 45V 1.5A	L	L	L	Full Step
	L	L	H	1/2
	L	H	L	1/4
	L	H	H	1/8
	H	L	L	1/16
	H	L	H	1/32
	H	H	L	1/128
	H	H	H	1/256
Driving Current Calculation Formula Rs=0.15Ω	$I_{peak} = \frac{V_{REF} * V_{DD}}{5 * R_S}$			

### 3.2.2 UART Mode of TMC Driver

For example, TMC2208, TMC2209, TMC2225... Use a jumper cap for each to connect the position of the red box in the figure, and the subdivision and driver current is set by firmware.

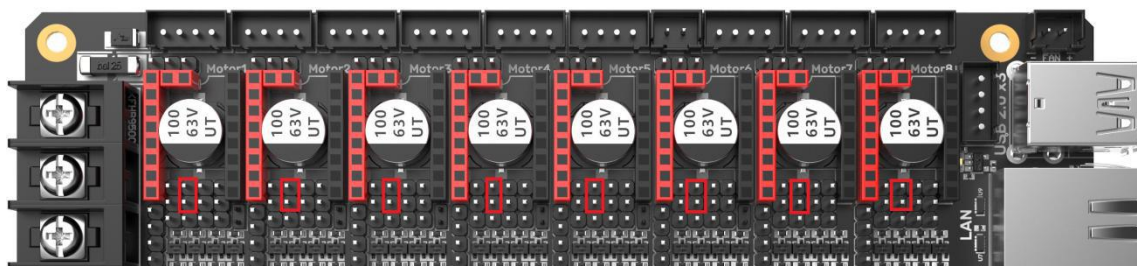

### 3.2.3 SPI Mode of TMC Driver

For example, TMC2130, TMC5160, TMC5161... Use 4 jumper caps for each to connect the position of the red box in the figure, and the subdivision and driver current is set by firmware.

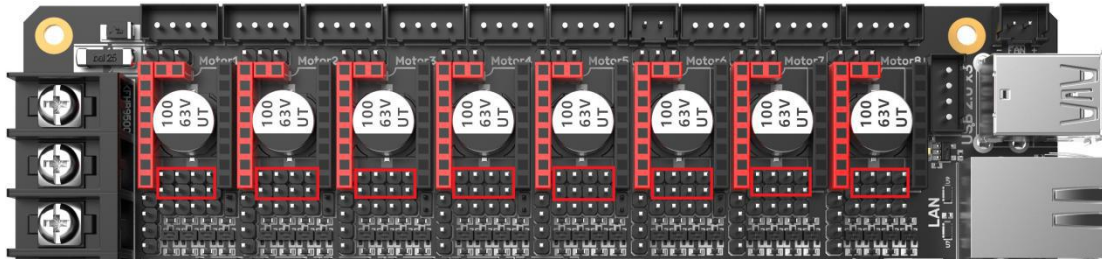

### 3.2.4 DIAG(Sensorless Homing) of TMC Driver

As shown in the figure, plug the jumper cap when using the Sensorless Homing function, and leave it unplugged when it is not used.

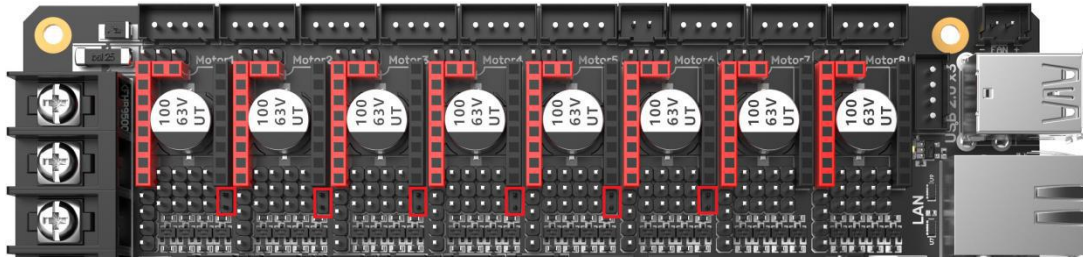

### 3.2.5 Selection of driving power supply for stepping motor

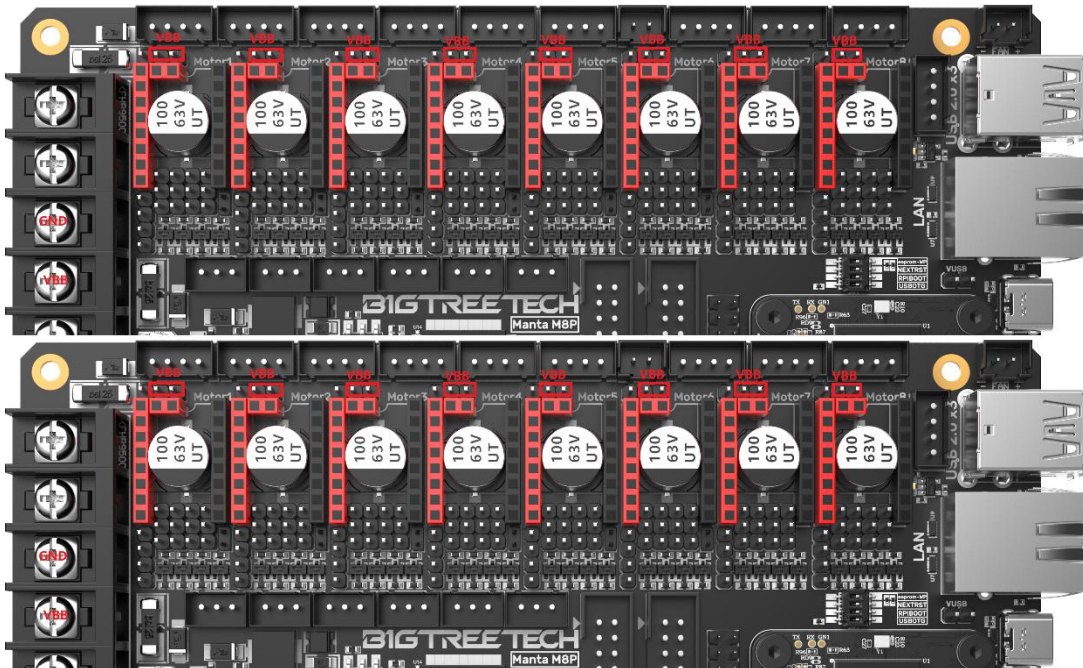

### 3.3 Installing the Core Board

M8P+CM4: Pay attention to the direction, as shown below.

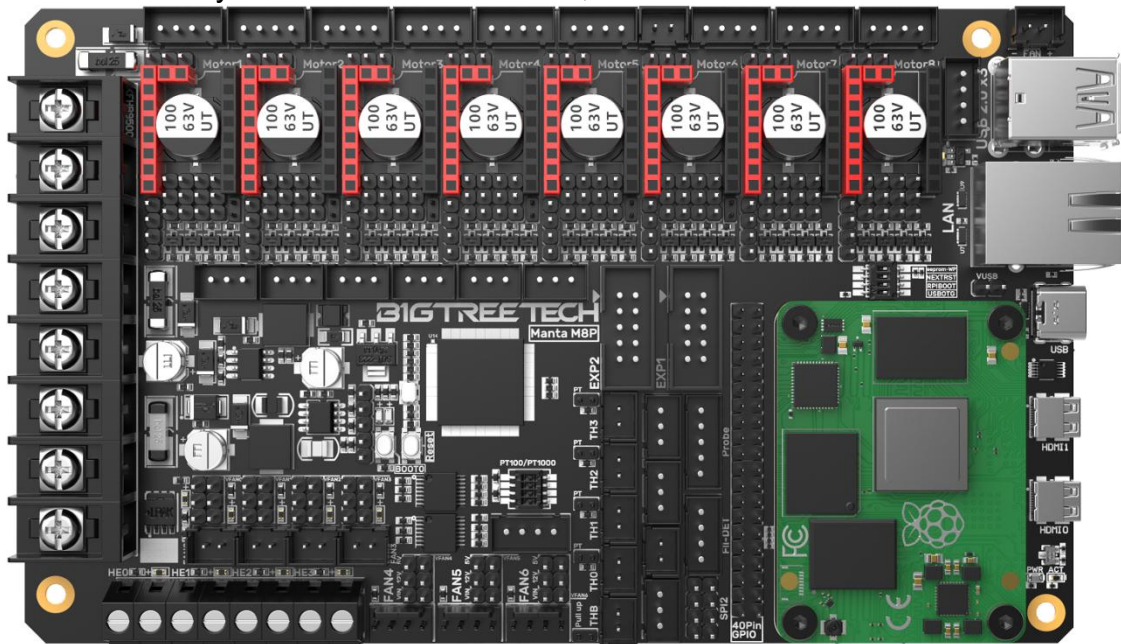

M8P+CB1: Pay attention to the direction, as shown below.

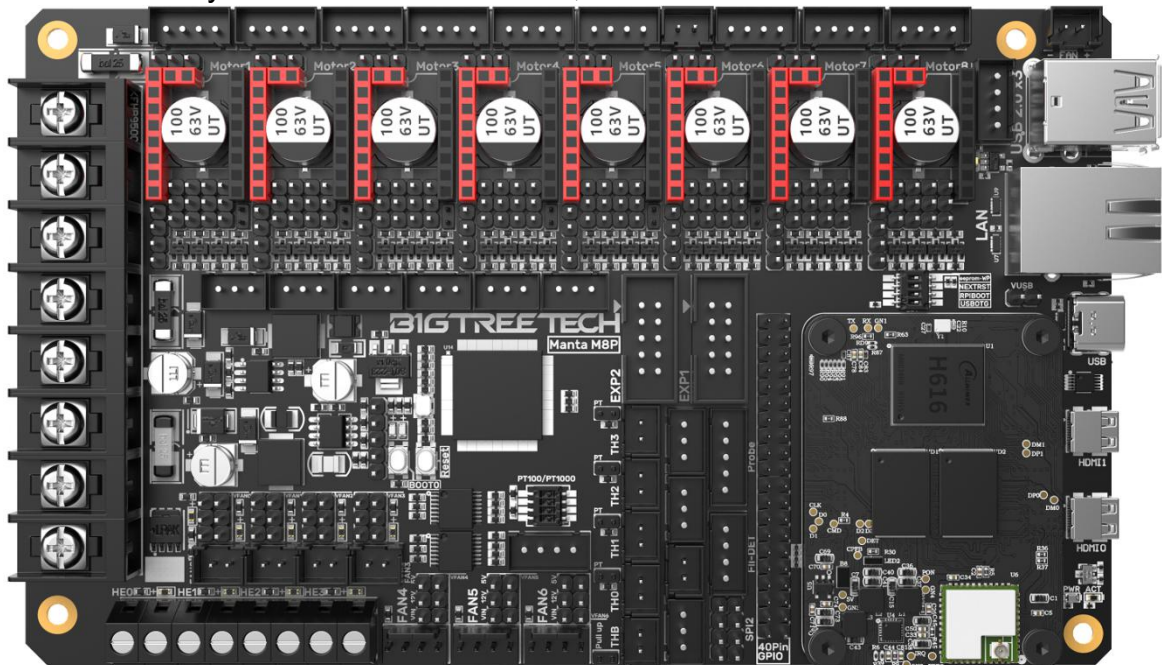



### 3.4 Voltage Selection of CNC Fans

Set the output voltage to 5V, 12V, or 24V with a jumper cap. **Note: Please confirm the fan's operating voltage before choosing a voltage. Our company is not responsible for fan burnout caused by wrong selection.**

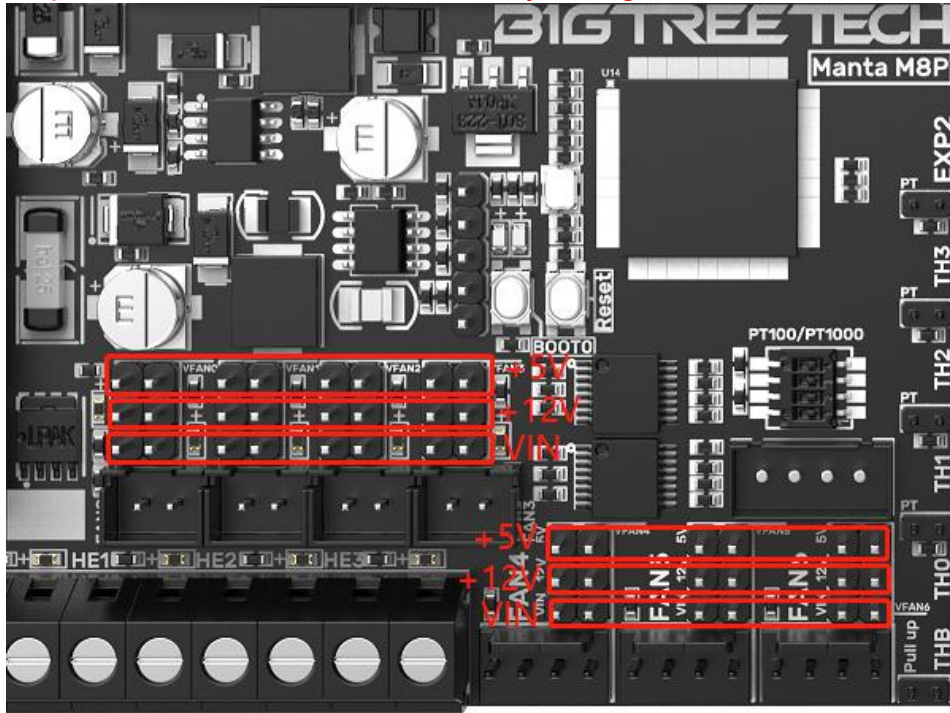

### 3.5 100K NTC or PT1000 Setting

When using a 100K NTC thermistor, there is no need to insert the jumper cap, and the pull-up resistance of TH0-TH3 is 4.7K 0.1%. When using PT1000, you need to use a jumper cap to connect the two pins in the red box in the figure below and connect a 4.12K 0.1% resistor in parallel. At this time, the pull-up resistor of TH0-TH1 is 2.2K (**Note: The temperature accuracy read out in this way will be far less accurate than that read out by MAX31865**).

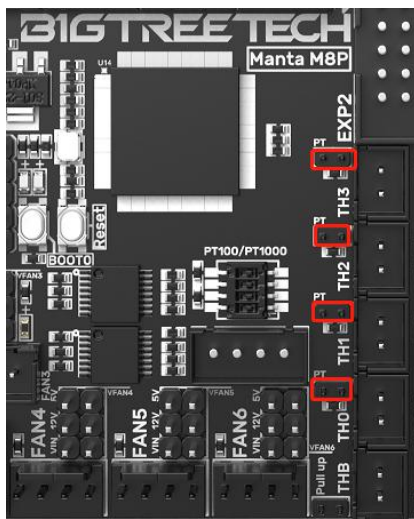

### 3.6 BLTouch Wiring

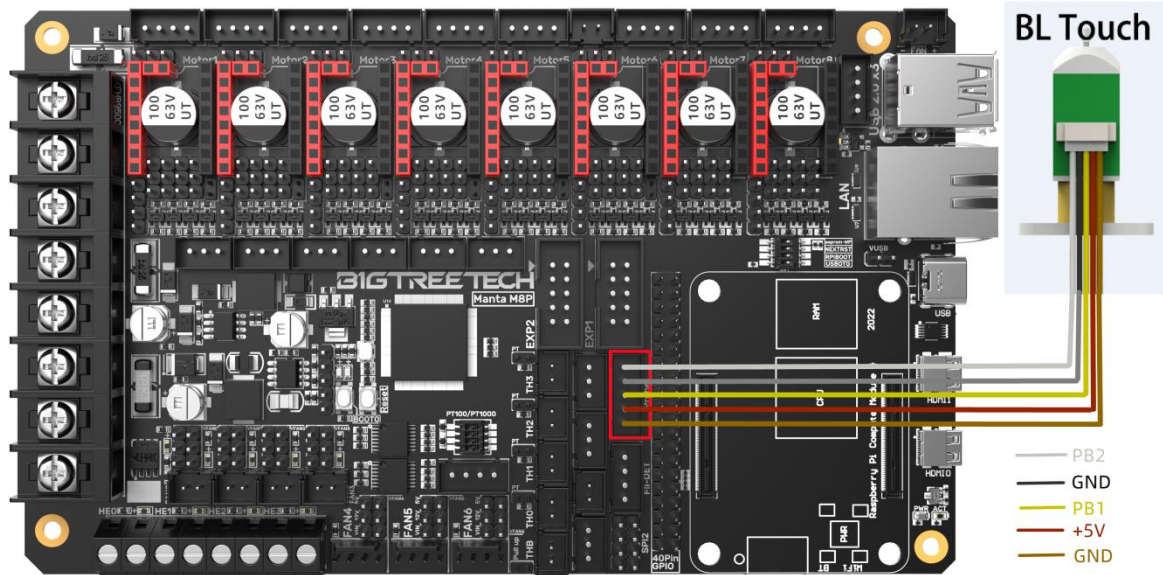

### 3.7 Auto Shutdown Module(Relay V1.2) Wiring

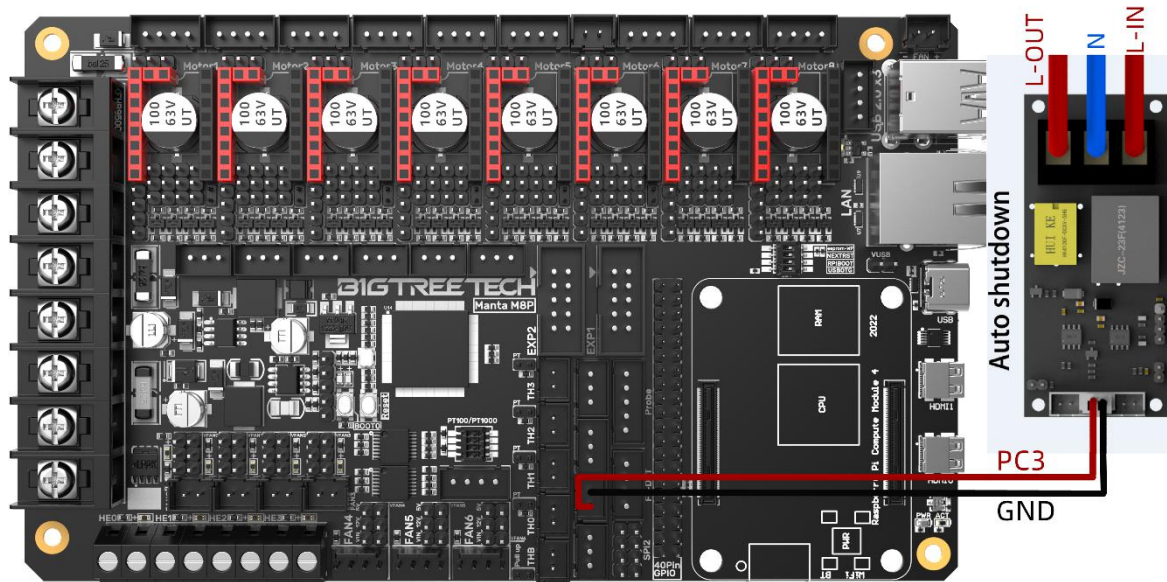

### 3.8 EXP1+EXP2 and LCD Screen Wiring

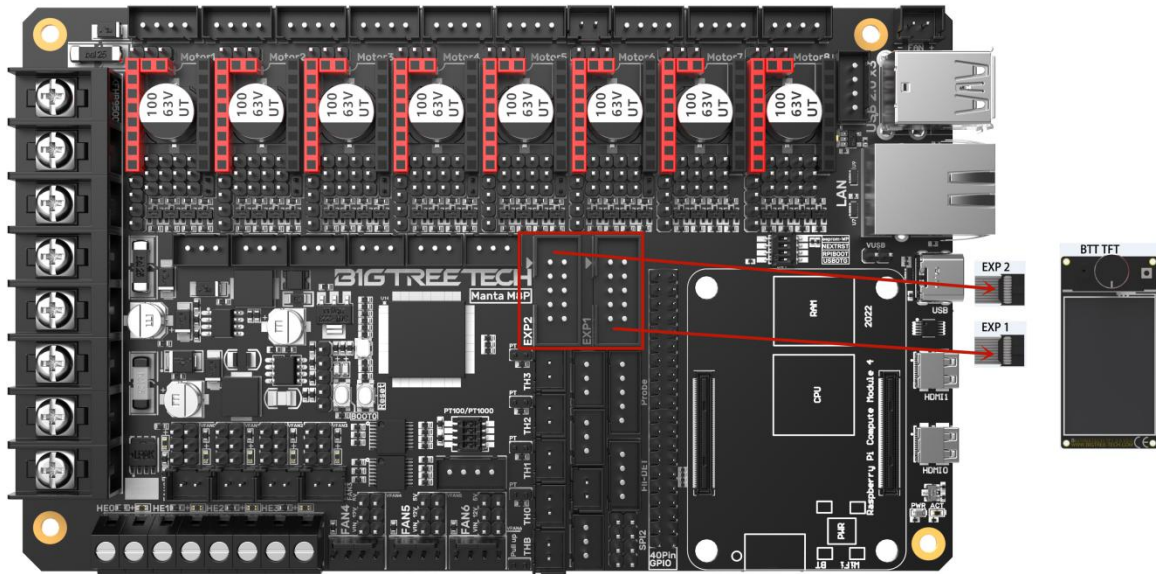

### 3.9 RGB Wiring

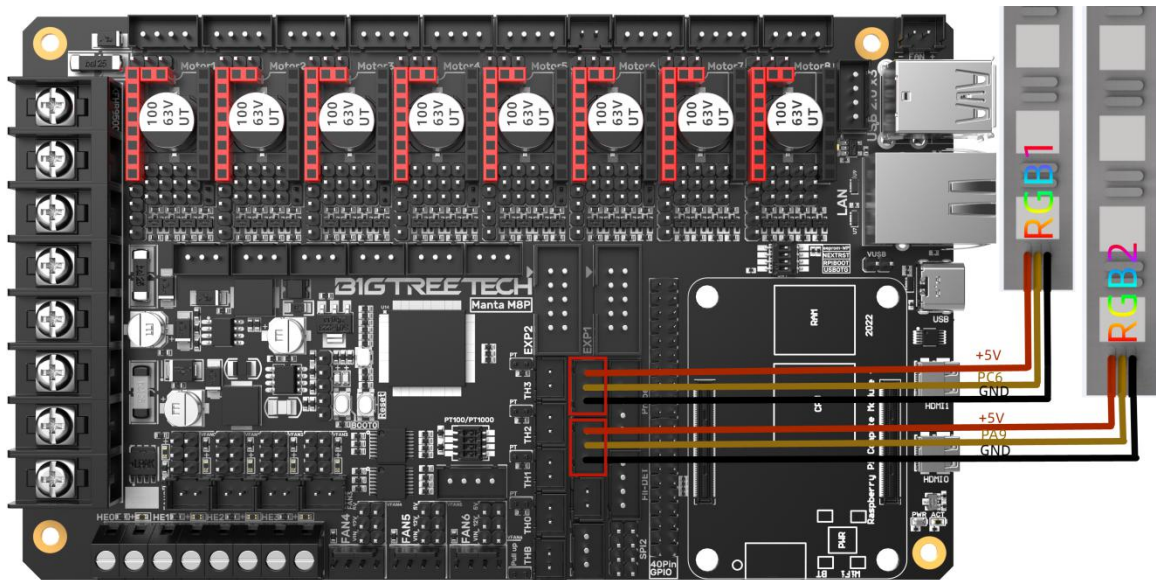

### 3.10 Filament Runout Detection Wiring

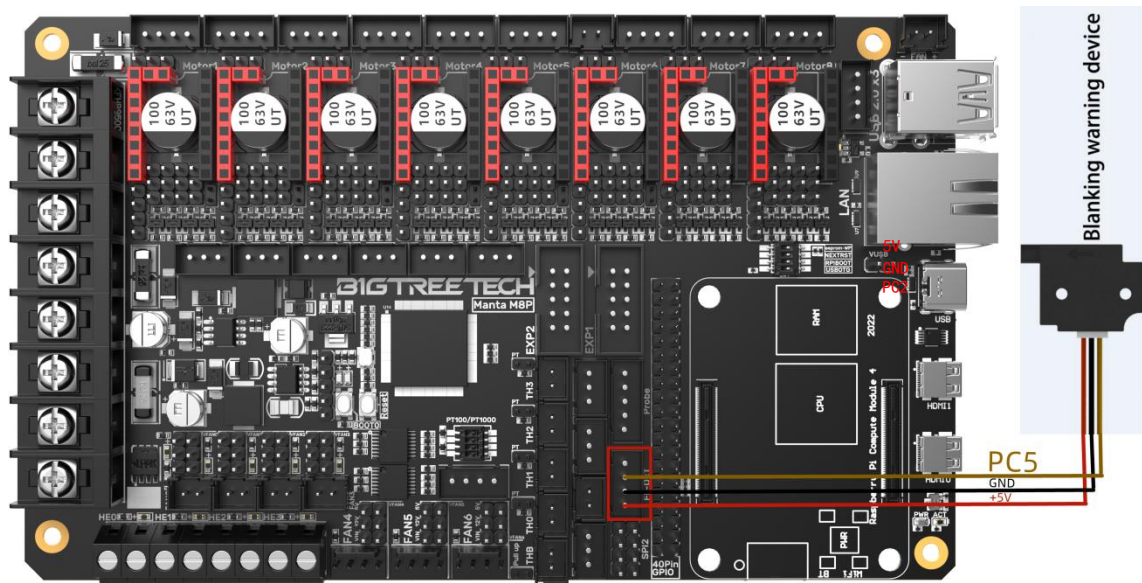

### 3.11 40 Pin GPIO

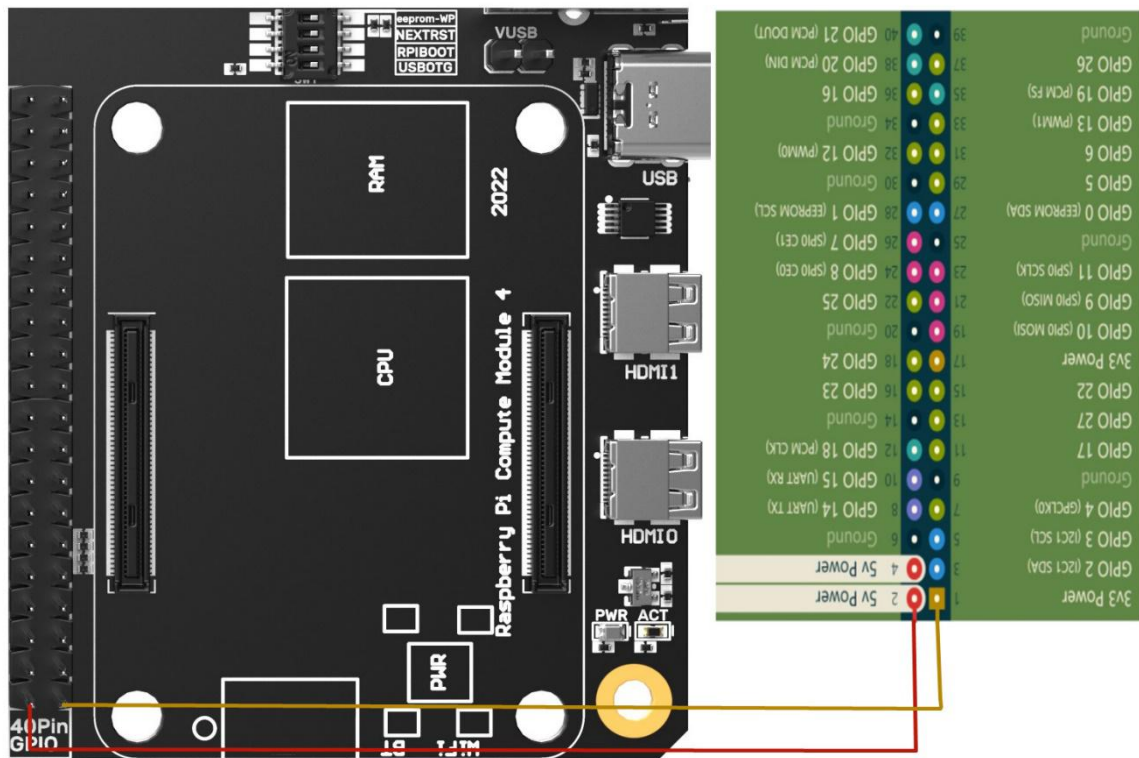

### 3.12 DSI/CSI Connection

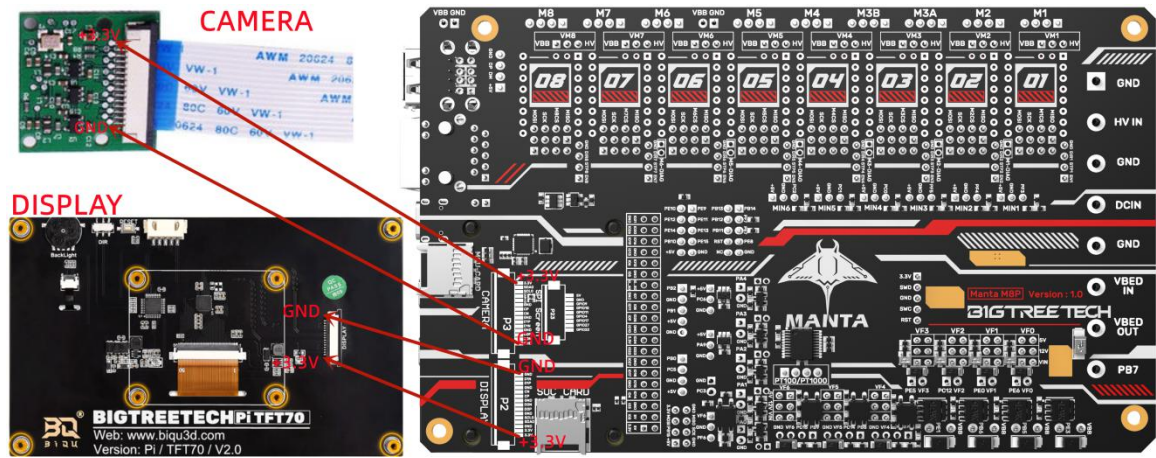

### 3.13 Proximity Switch Wiring

Always on (NPN type), no need to short-circuit via a jumper cap, 24V as an example, as shown in the following figure:

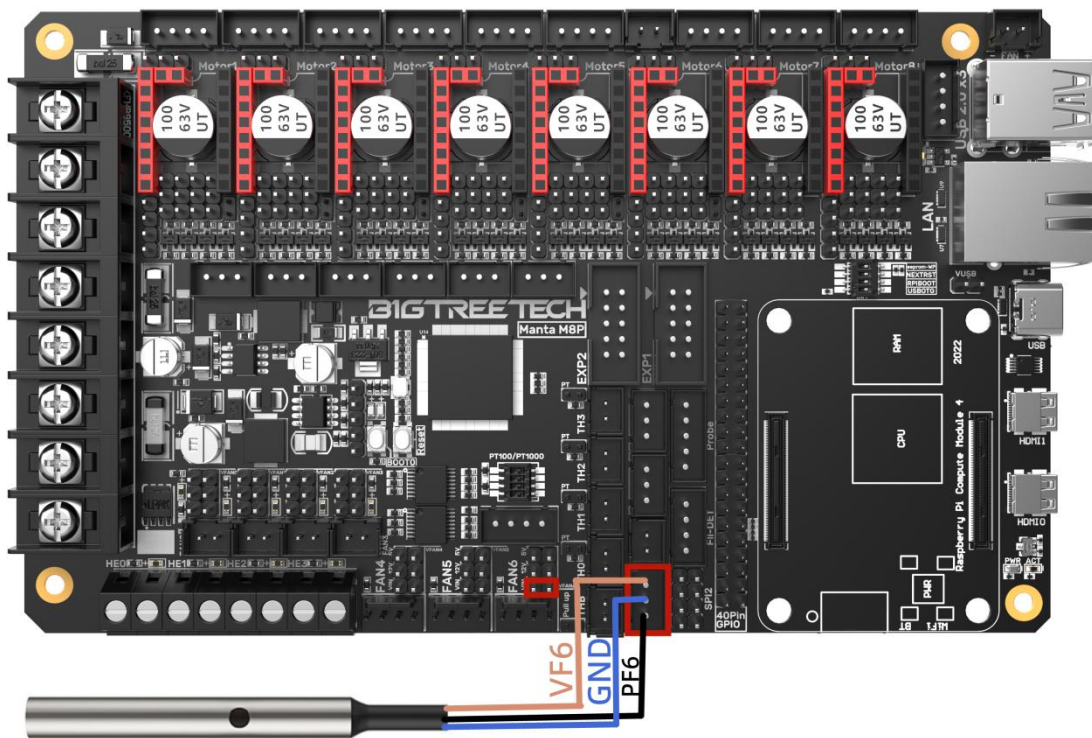

Always off (PNP type), need to short-circuit via a jumper cap, 24V as an example, as shown in the following figure:

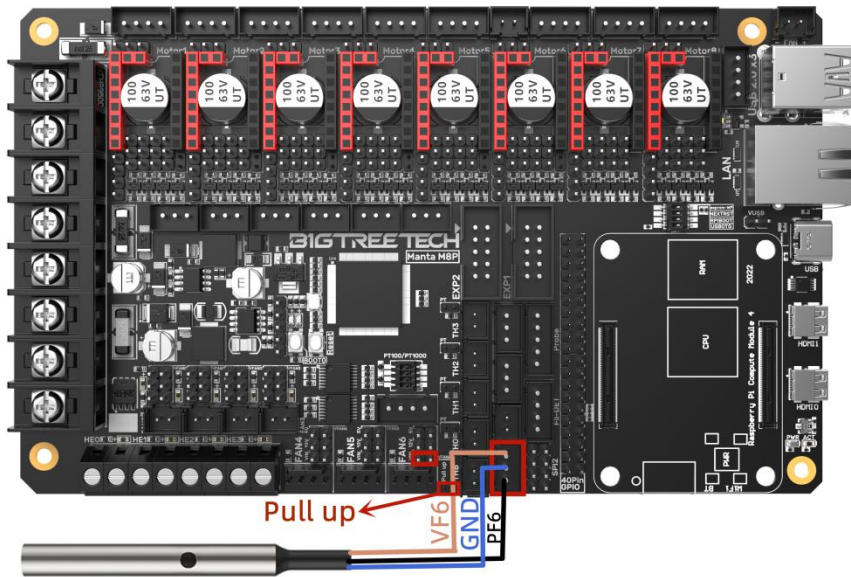

3.14 Wiring of the 4-wire CNC Fan and the Water Cooling Device  
12V as an example, as shown in the following figure:

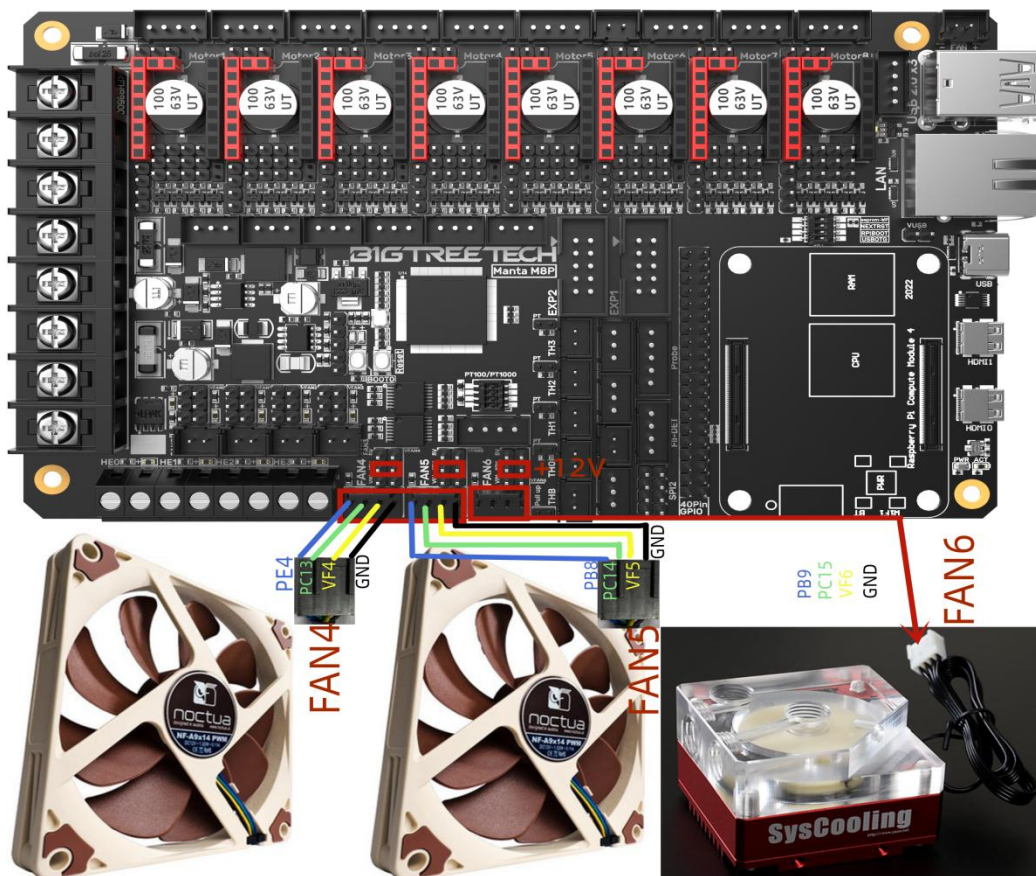

### 3.15 ADXL345 accelerometer

Refer to here: [https://www.klipper3d.org/Measuring\\_Resonances.html](https://www.klipper3d.org/Measuring_Resonances.html), We can refer to the following wiring and configuration when connecting to the M8P motherboard

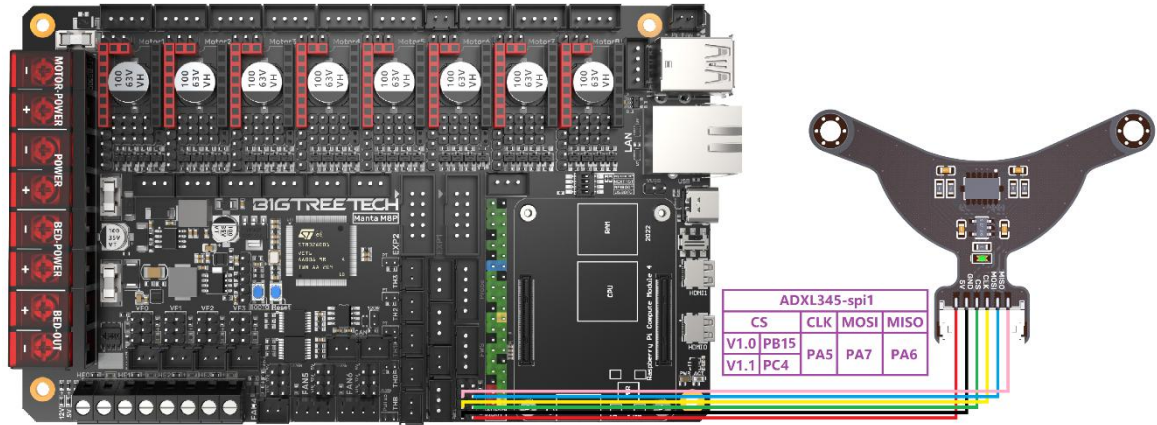

```
[adxl345]
cs_pin: PC4 # PB15 for V1.0
spi_bus: spi1
#spi_software_sclk_pin: PA5
#spi_software_mosi_pin: PA7
#spi_software_miso_pin: PA6
```

## 4. Raspberry Pi CM4 Setup steps

### 4.1 Download OS Image

If CM4 core board is used, You can directly download the images of Fluidd or Mainsail, also can download the OS image from the official website of Raspberry Pi

Fluidd: <https://github.com/fluid-core/FluiddPI/releases>

Mainsail: <https://github.com/mainsail-crew/MainsailOS/releases>

Raspberry Pi official OS: <https://www.raspberrypi.com/software/operating-systems>

(CM4 needs to refer to the following system settings to enable the system's USB, DSI and other interfaces, whose operation is slightly different from the standard Raspberry Pi 3B, 4B, etc.)

#### Raspberry Pi OS

Our recommended operating system for most users.

Compatible with:

All Raspberry Pi models

#### Raspberry Pi OS with desktop

Release date: January 28th 2022  
System: 32-bit  
Kernel version: 5.10  
Debian version: 11 (bullseye)  
Size: 1.246MB  
Show SHA256 file integrity hash:  
[Release notes](#)

Download

[Download torrent](#)  
[Archive](#)

#### Raspberry Pi OS with desktop and recommended software

Release date: January 28th 2022  
System: 32-bit  
Kernel version: 5.10  
Debian version: 11 (bullseye)  
Size: 3.267MB  
Show SHA256 file integrity hash:  
[Release notes](#)

Download

[Download torrent](#)  
[Archive](#)

#### Raspberry Pi OS Lite

Release date: January 28th 2022  
System: 32-bit  
Kernel version: 5.10  
Debian version: 11 (bullseye)  
Size: 482MB  
Show SHA256 file integrity hash:  
[Release notes](#)

Download

[Download torrent](#)  
[Archive](#)

### 4.2 Download and Install Raspberry Pi Imager

Install the official Raspberry Pi Imager: <https://www.raspberrypi.com/software/>



## 4.3 Write OS Image

### 4.3.1 CM4 LITE Version (Micro SD Card)

1. Plug the Micro SD card into the computer via a card reader.
2. Select Operating System.

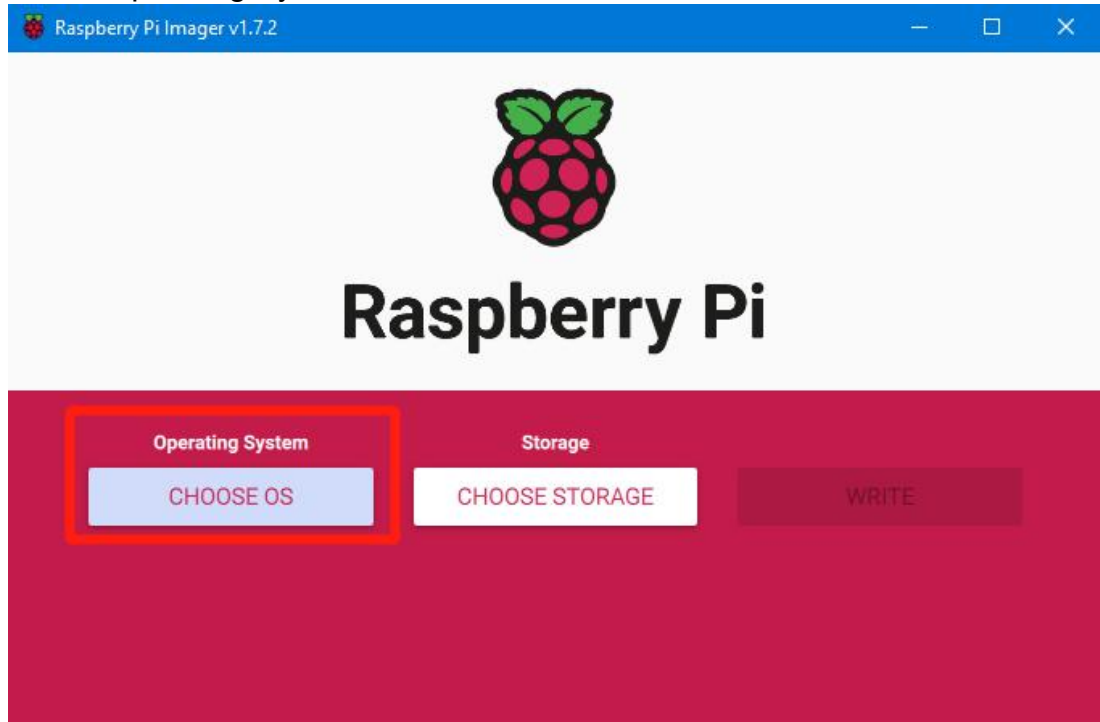

3. Select "Use Custom", then select a custom.img from your computer.

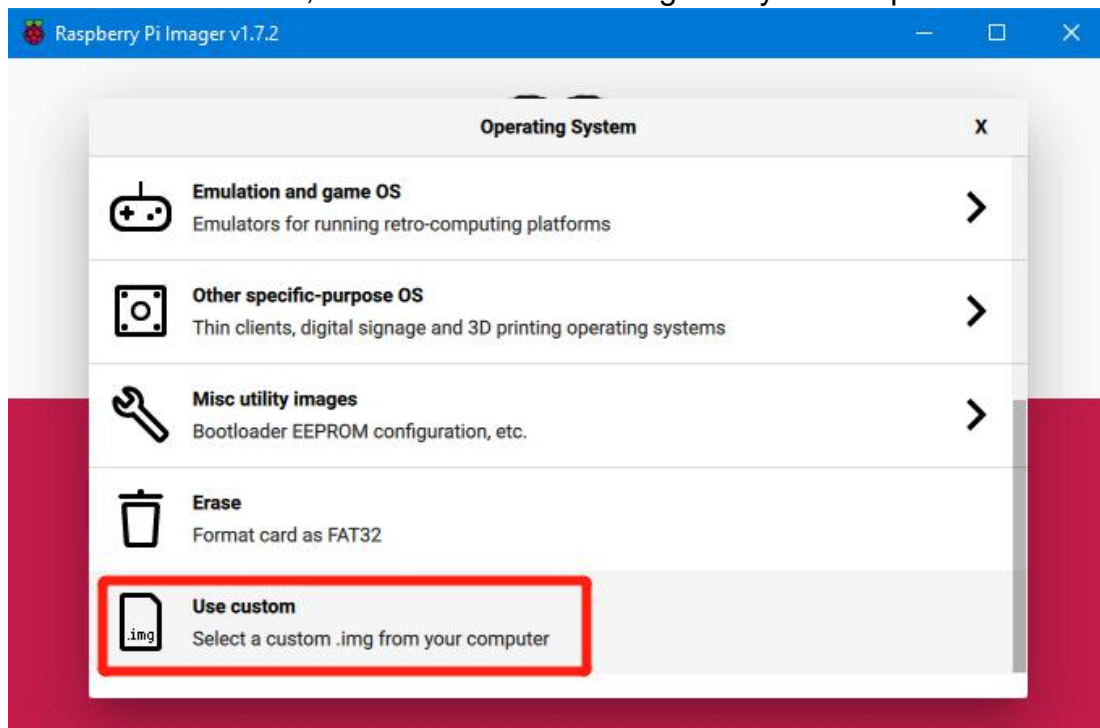

4. Click the setting icon in the lower right corner



5. “Enable SSH”and click“SAVE”, There are other features that can be set in this menu. Please modify them according to your own needs. Details are as follows:

Set hostname: raspberrypi.local //Custom hostname Default:raspberrypi.local

Enable SSH

Set username and password // Custom username and password, Default username: pi password: raspberry

Configure wireless LAN // Custom the SSID and password of WLAN

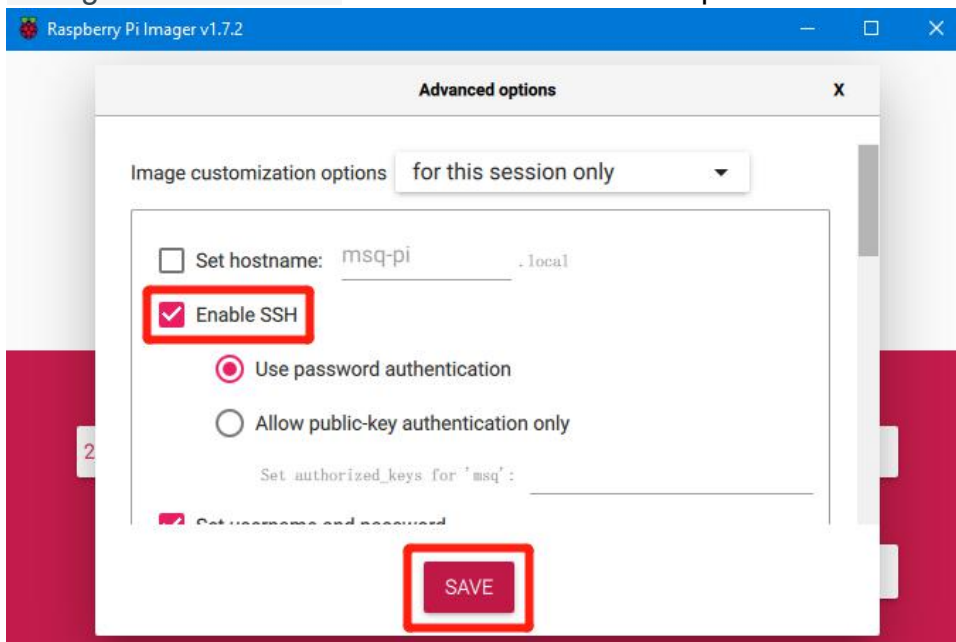

6. Select the Micro SD card and click "WRITE" (Writing the image will format the Micro SD card. Be careful not to select the wrong storage device, otherwise, the data will be formatted).



7. Wait for the writing to finish.

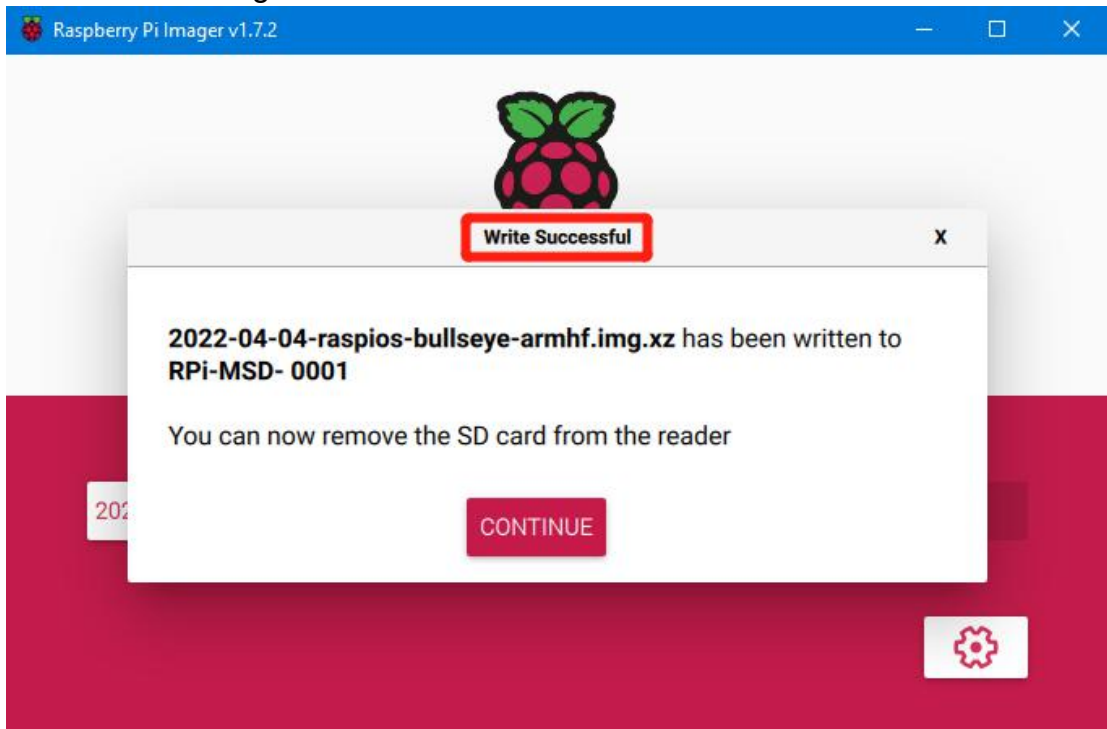

#### 4.3.2 CM4 eMMC Version(Note: eMMC version will not tun the system from the Micro SD card.)

1. Install rpiboot  
For Windows:  
[http://github.com/raspberrypi/usbboot/raw/master/win32/rpiboot\\_setup.exe](http://github.com/raspberrypi/usbboot/raw/master/win32/rpiboot_setup.exe)  
For Mac and Linux:  
<https://github.com/raspberrypi/usbboot#building>
2. Push the DIP switch 4 (USB OTG) and 3 (RPIBOOT) to ON to enter BOOT mode.

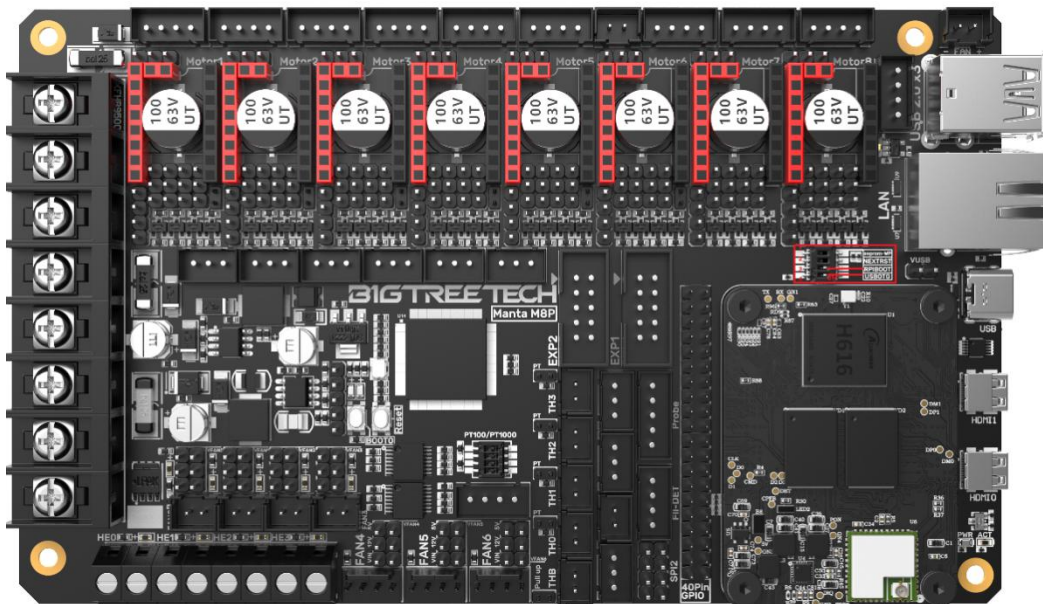

3. Plug the Type-C into the USB port of the computer(in order to avoid problems caused by the insufficient USB power supply of the computer, it is best to use an external 24V power supply to power the motherboard). Run `sudo ./rpiboot`(Mac/Linux) or `rpiboot.exe` on Windows, then the eMMC of CM4 will be recognized as a mass storage device by the computer (if rpiboot reports an error at this time, you can try to re-plug the USB).
4. The step of using the Raspberry Pi Imager to write the OS image is exactly the same as the LITE version. Note: the SSH function should also be enabled.
5. When the writing is completed, push the DIP switch 4 (USB OTG) and 3 (RPIBOOT) back to OFF after power off, and power on again to enter the normal working mode.

### 4.4. System Settings (CM4)

#### 4.4.1 USB 2.0 Hub Ports

MANTA M8P is designed with a USB 2.0 Hub, in order to save power consumption, the USB port of CM4 is disabled by default. If you want to enable it,

you need to add the following content to the config.txt file:

```
dtoverlay=dwc2,dr_mode=host
```

#### 4.4.2 DSI1 Display Interface

The default display interface is HDMI. The onboard DSI port of MANTA M8P uses the DSI1 interface. You need to download the DSI1 driver and enter the following sentence in the command line:

```
sudo wget https://datasheets.raspberrypi.com/cmio/dt-blob-disp1-cam1.bin -O /boot/dt-blob.bin
```

After downloading this driver and restarting, the screen of DSI1 will work normally. If you want to use the HDMI interface, you need to delete the downloaded /boot/dt-blob.bin driver and restart, then the HDMI can output normally.

#### 4.4.3 CSI1 Camera

The DSI1 driver downloaded in **4.4.2 DSI1 Display Interface** also includes the CSI1 driver. If you just want to install the CSI1 driver, not DSI1, please find the driver you want to use at <https://datasheets.raspberrypi.com/licence.html> and download it in the boot folder of CM4 and rename it to dt-blob.bin, and then refer to the settings here.

<https://projects.raspberrypi.org/en/projects/getting-started-with-picamera/>

## 5. **BIGTREETECH CB1** Setup steps

### 5.1 Download OS Image

If **BIGTREETECH CB1 core board is used**, You can only download and install the system image provided by BIGTREETECH:

<https://github.com/bigtreotech/CB1/releases>

## 5.2 Download and Install Raspberry Pi Imager

Install the official Raspberry Pi Imager: <https://www.raspberrypi.com/software/>  
The system image of **CB1** can also be written with this software.

## 5.3 Write OS Image

1. Plug the Micro SD card into the computer via a card reader.
2. Select Operating System.



3. Select "Use Custom", then select a custom.img from your computer.

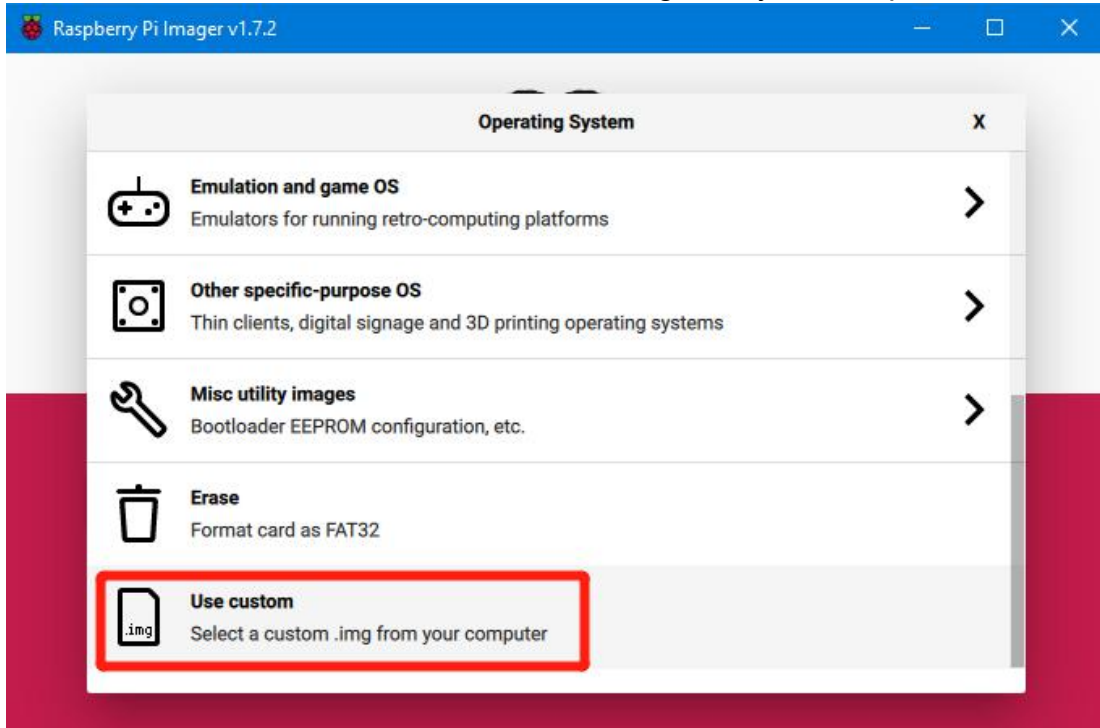

4. Select the Micro SD card and click "WRITE" (Writing the image will format the Micro SD card. Be careful not to select the wrong storage device, otherwise, the data will be formatted).



5. Wait for the writing to finish.

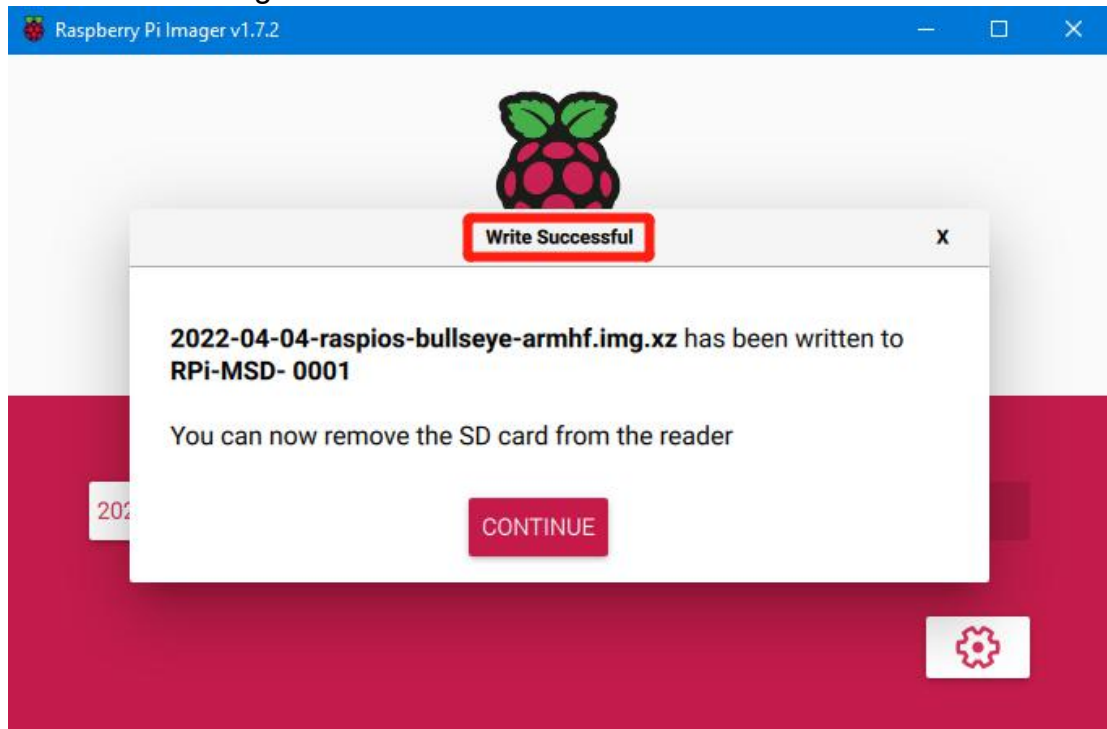

### 5.4 WIFI Setting

Note: This step can be skipped if you are using a network cable connection.

CB1 cannot directly use the Raspberry Pi Imager to set the WiFi name

and password like CM4. After the OS image writing is completed, the MicroSD card will have a FAT32 partition recognized by the computer, find "system.cfg"

名称	修改日期	类型	大小
dtb	2022/11/9 2:50	文件夹	
dtb-5.16.17-sun50iw9	2022/11/9 2:50	文件夹	
gcode	2022/11/9 10:35	文件夹	
.next	2022/11/9 2:50	NEXT 文件	0 KB
BoardEnv.txt	2022/11/9 2:53	文本文档	1 KB
boot.bmp	2022/11/9 2:52	BMP 图像	10 KB
boot.cmd	2022/11/9 2:48	Windows 命令脚本	4 KB
boot.scr	2022/11/9 2:53	屏幕保护程序	4 KB
config-5.16.17-sun50iw9	2022/11/9 2:39	17-SUN50IW9 ...	176 KB
Image	2022/11/9 2:39	文件	20,631 KB
initrd.img-5.16.17-sun50iw9	2022/11/9 2:54	17-SUN50IW9 ...	9,171 KB
system.cfg	2022/11/10 17:52	文本文档	1 KB
System.map-5.16.17-sun50iw9	2022/11/9 2:39	17-SUN50IW9 ...	4,239 KB
uInitrd	2022/11/9 2:54	文件	9,171 KB
vmlinuz-5.16.17-sun50iw9	2022/11/9 2:39	17-SUN50IW9 ...	20,631 KB



Open it with Notepad, replace WIFI-SSID with your WiFi name, and PASSWORD with your password.

```
system.cfg X
J: > system.cfg
1 | #-----#
2 | check_interval=5      # Cycle to detect whether wifi is connected, time 5s
3 | router_ip=8.8.8.8    # Reference DNS, used to detect network connections
4 |
5 | eth=eth0             # Ethernet card device number
6 | wlan=wlan0          # Wireless NIC device number
7 |
8 | #####
9 | # wifi name
10 | WIFI_SSID="Your SSID"
11 | # wifi password
12 | WIFI_PASSWD="Your Password"
13 |
14 | #####
15 | WIFI_AP="false"     # Whether to open wifi AP mode, default off
16 | WIFI_AP_SSID="rtl8189" # Hotspot name created by wifi AP mode
17 | WIFI_AP_PASSWD="12345678" # wifi AP mode to create hotspot connection password
```

## 6. Configure the motherboard

### 6.1 ssh connect to device

1. Install the ssh application Mobaxterm:  
<https://mobaxterm.mobatek.net/download-home-edition.html>
2. Insert Micro SD card to MANTA M8P, wait for system to load after power on, aprox. 1-2min
3. The device will automatically be assigned a IP address after successfully connected to the network
4. Find the device IP address in your router page



5. Or use the <https://angryip.org/> tool, scan all IP address in the current network organize by names, find the IP named Fluidd, Mailsail (CM4) or Hurakan

Shenzhen Big Tree Technology Co., Ltd.  
**BIGTREETECH**

---

(CB1) like shown below

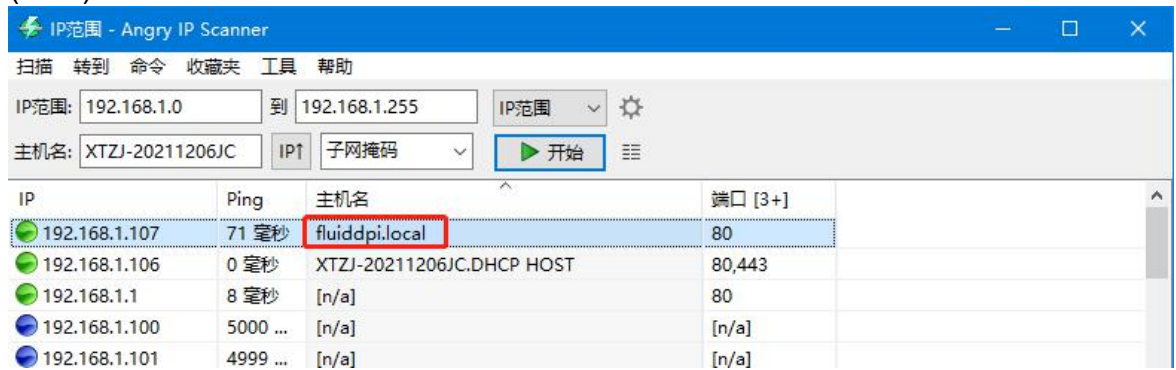

The screenshot shows the Angry IP Scanner application window. The interface is in Chinese. At the top, there are menu options: 扫描 (Scan), 转到 (Go to), 命令 (Command), 收藏夹 (Favorites), 工具 (Tools), and 帮助 (Help). Below the menu, there are input fields for IP range (192.168.1.0 to 192.168.1.255) and a host name (XTZJ-20211206JC). A '开始' (Start) button is visible. The main area displays a table of scan results.

IP	Ping	主机名	端口 [3+]
192.168.1.107	71 毫秒	fluidpi.local	80
192.168.1.106	0 毫秒	XTZJ-20211206JC.DHCP HOST	80,443
192.168.1.1	8 毫秒	[n/a]	80
192.168.1.100	5000 ...	[n/a]	[n/a]
192.168.1.101	4999 ...	[n/a]	[n/a]

- Open MobaXterm and click “Session”, and click “SSH”, inset the device IP into Remote host and click “OK” (note: your computer and the device needs to be in the same network)

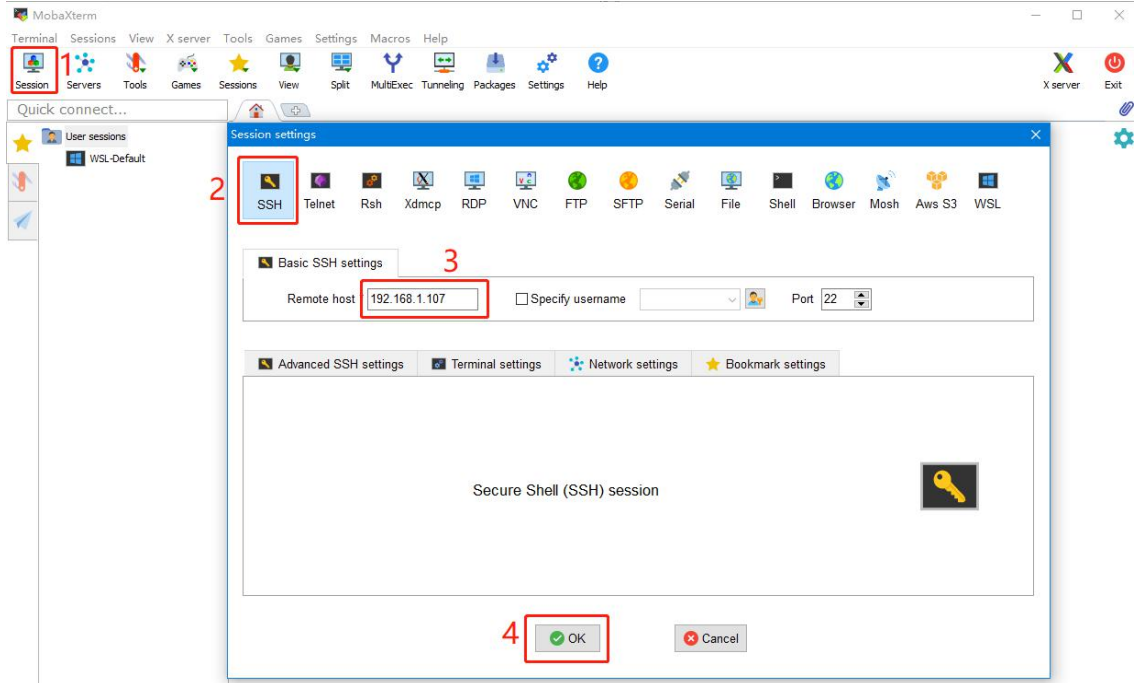

- Input the login name and password to enter the SSH terminal interface

CM4:

login as: pi  
password: raspberry

CB1:

login as: biqu  
password: biqu

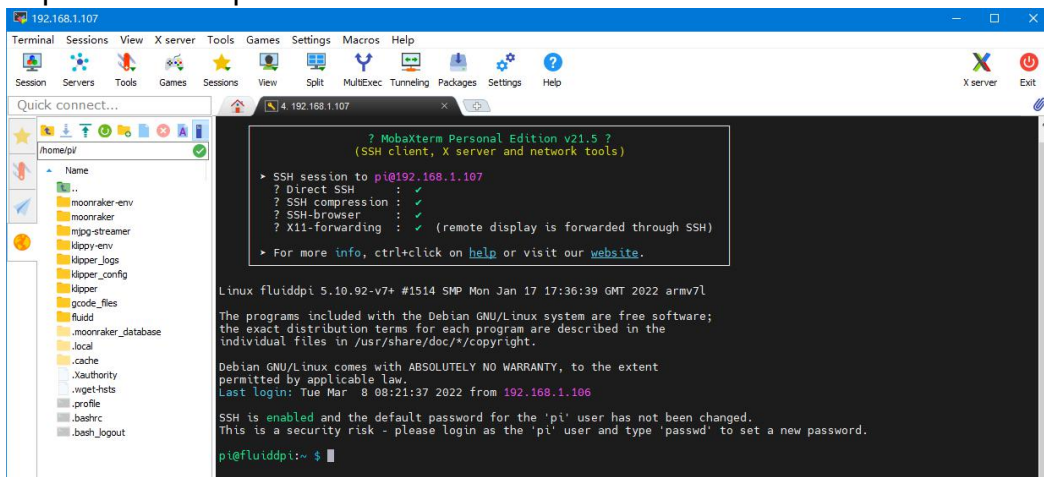

## 6.2 Compile firmware

1. After ssh successfully connected to the device, enter in terminal:

```
cd ~/klipper/  
make menuconfig
```

Compile with the configuration shown below(if the options below is not available, please update you Klipper source code to the newest version)

- \* [\*] Enable extra low-level configuration options
- \* Micro-controller Architecture (STMicroelectronics STM32) --->
- \* Processor model (STM32G0B1) --->
- \* Bootloader offset (8KiB bootloader) --->
- \* Clock Reference (8 MHz crystal) --->
- \* Communication interface (USB (on PA11/PA12)) --->

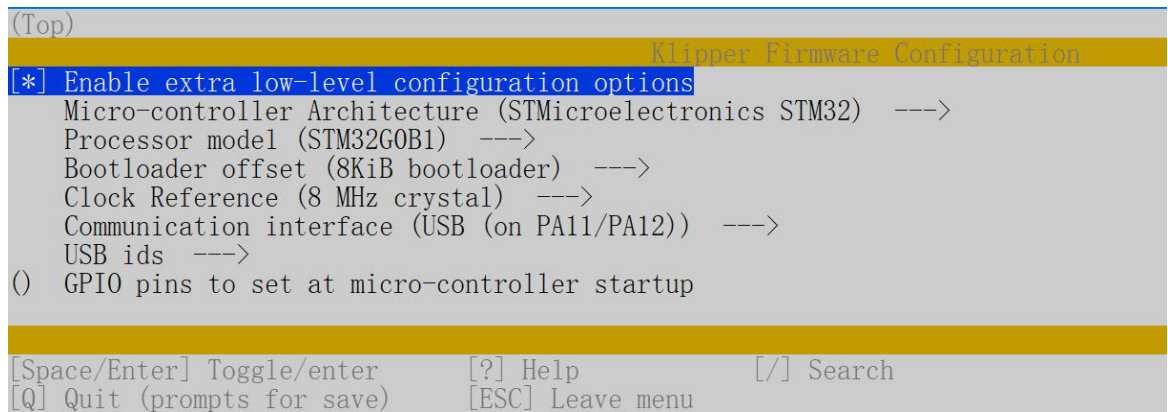

2. Press q to exit, and Yes when asked to save the configuration
3. Run make to compile firmware, "klipper.bin" file will be generated in home/pi/klipper/out folder when make is finished, download it onto your computer using the ssh application.

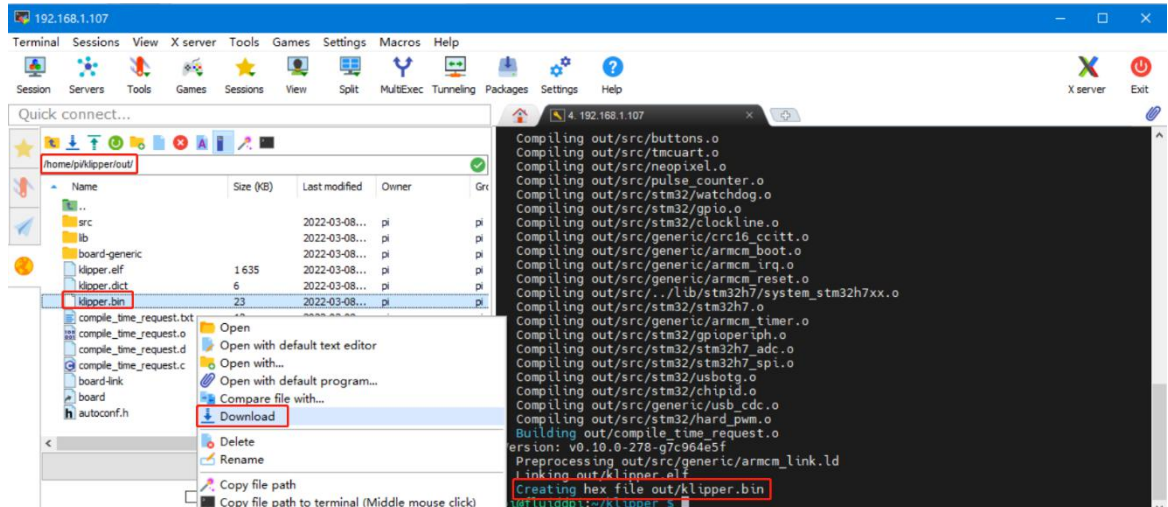

## 6.3 Firmware update

### 6.3.1 Update using SD Card

1. Rename klipper.bin to "firmware.bin", Copy to the SD card root directory, insert the SD card into the SD card slot of the MANTA M8P, click the "reset" button or power on again. The firmware will be updated automatically. After the update, the "firmware.bin" in the SD card will be renamed as "FIRMWARE.CUR".
2. Enter: `ls /dev/serial/by-id/` in terminal to check motherboard ID to confirm whether firmware is updated successfully like shown below.

```
pi@fluiddpi:~/klipper $ ls /dev/serial/by-id/  
usb-Klipper_stm32g0b1xx_190028000D50415833323520-if00  
pi@fluiddpi:~/klipper $
```

copy and save this ID, it is needed when modifying klipper config

### 6.3.2 Update using DFU

If the MCU klipper device ID can be found by `ls /dev/serial/by-id/`, we can input:

`make flash FLASH_DEVICE= /dev/serial/by-id/usb-Klipper_stm32g0b1xx_190028000D50415833323520-if00`  
to update firmware (NOTE: Replace `/dev/serial/by-id/xxx` with the actual ID found in the previous step)

```
biq@Hurakan:~/klipper$ make flash FLASH_DEVICE=/dev/serial/by-id/usb-Klipper_stm32g0b1xx_190028000D50415833323520-if00  
Building hid-flash  
/bin/sh: 1: pkg-config: not found  
hid-flash requires libusb-1.0, please install with:  
sudo apt-get install libusb-1.0  
Flashing out/klipper.bin to /dev/serial/by-id/usb-Klipper_stm32g0b1xx_190028000D50415833323520-if00  
Entering bootloader on /dev/serial/by-id/usb-Klipper_stm32g0b1xx_190028000D50415833323520-if00  
Device reconnect on /sys/devices/platform/soc/52000000.usb/usb1/1-1/1-1.1/1-1.1:1.0  
sudo dfu-util -p 1-1.1 -R -a 0 -s 0x8002000:leave -D out/klipper.bin  
  
dfu-util 0.9  
  
Copyright 2005-2009 Weston Schmidt, Harald Welte and OpenMoko Inc.  
Copyright 2010-2016 Tormod Volden and Stefan Schmidt  
This program is Free Software and has ABSOLUTELY NO WARRANTY  
Please report bugs to http://sourceforge.net/p/dfu-util/tickets/  
  
dfu-util: Invalid DFU suffix signature  
dfu-util: A valid DFU suffix will be required in a future dfu-util release!!!  
Opening DFU capable USB device...  
ID 0483:df11  
Run-time device DFU version 011a  
Claiming USB DFU Interface...  
Setting Alternate Setting #0 ...  
Determining device status: state = dfuIDLE, status = 0  
dfuIDLE, continuing  
DFU mode device DFU version 011a  
Device returned transfer size 1024  
DfuSe interface name: "Internal Flash"  
Downloading to address = 0x08002000, size = 25264  
Download [=====] 100% 25264 bytes  
Download done.  
File downloaded successfully  
dfu-util: Error during download get_status  
  
Failed to flash to /dev/serial/by-id/usb-Klipper_stm32g0b1xx_190028000D50415833323520-if00: Error running dfu-util  
  
If the device is already in bootloader mode it can be flashed with the  
following command:  
make flash FLASH_DEVICE=0483:df11  
OR  
make flash FLASH_DEVICE=1209:beba  
  
If attempting to flash via 3.3V serial, then use:  
make serialflash FLASH_DEVICE=/dev/serial/by-id/usb-Klipper_stm32g0b1xx_190028000D50415833323520-if00
```

There will be an error message "dfu-util: Error during download get\_status" after update. Just ignore it.

## 6.4 Configure Klipper

1. Enter your device IP address into your browser to open the webUI, find the reference config for motherboard in the directory shown below, if there is no such config available, update your klipper source code to the newest version or download from github: <https://github.com/bigtreetech/Manta-M8P>

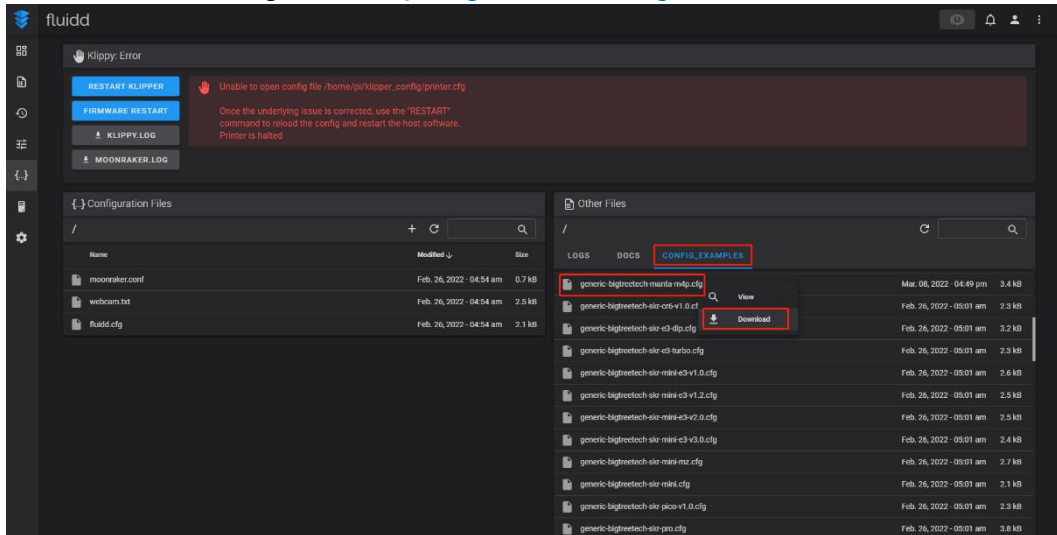

2. Upload your finished config file into Configuration Files, and rename to "printer.cfg"

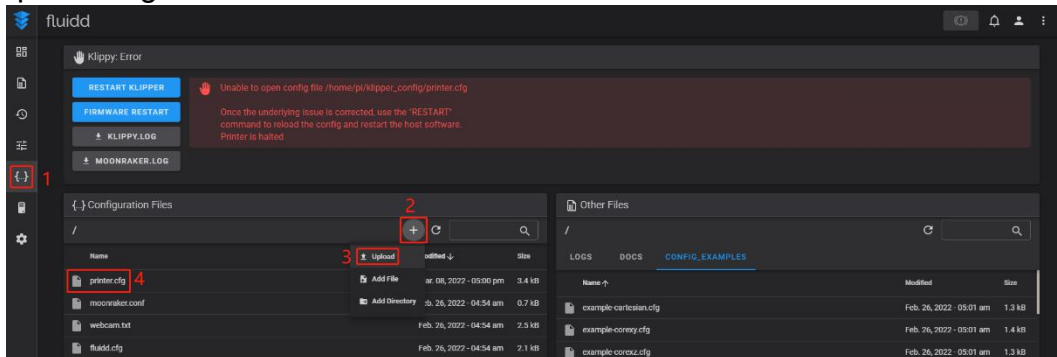

3. Insert the correct motherboard ID

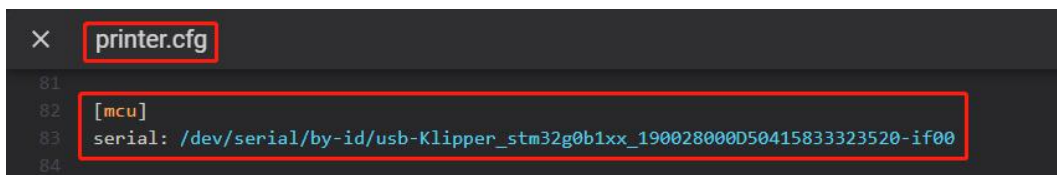

Refer to <https://www.klipper3d.org/Overview.html> for detailed configuration guide according to your machine type.

## 7 Precautions

1. All unplugging and plugging operations should be performed under the condition of power off, including enabling the eMMC writing.
2. Pay attention to the heat dissipation of CM4 and CB1. The CM4/CB1 may become quite hot if the running application consumes too many system resources.

Other resources for this product can be found on <https://github.com/bigtreotech/>. If you cannot find the resources you need, you can contact our after-sales support.

We want to hear from you if you encounter any other problems while using our products, and we will answer them as quickly as possible; any good ideas or suggestions on our products will also be considered carefully. Thank you for choosing BIGTREETECH. Your support means a lot to us!