

DK32S

ENTERPRISE REMOTE CONTROLLER USER MANUAL



V1.3

May 2022

Thank you for purchasing SIYI's product.

DK32S is a professional, intelligent, and universal radio system, integrated with 2.4 GHz datalink and advanced digital frequency hopping technology. DK32S supports up to 20 kilometers of control range as well as the telemetry range, and 16 communication channels. The system is perfectly compatible with popular flight controllers on market. DK32S remote controller comes with a high-brightness touchscreen for configuration, easy and convenient.

To maintain a safe and orderly public space and to ensure you a good using experience of DK32S remote controller, please read this manual carefully. If you have any issue using the product, please consult the manual or check the online pages of DK32S on SIYI official website (<http://en.siyi.biz/>). You can also write an email to SIYI official A/S center (support@siyi.biz).

SIYI User Group - Facebook



SIYI YouTube Channel (<https://www.youtube.com/c/SIYITech>)

SIYI Official AliExpress Store (<https://siyi.aliexpress.com>)

CONTENT

1 READ TIPS	- 7 -
1.1 Icon Definition	- 7 -
1.2 Flight Safety	- 7 -
1.3 Precautions on Charging	- 9 -
1.4 Precautions on Using SD Card	- 10 -
1.5 Precautions on Storage/Carrying/Recycling	- 11 -
2 PRODUCT INTRODUCTIONS	- 12 -
2.1 Product Features	- 12 -
2.2 Parts	- 15 -
2.2.1 At a Glance	- 15 -
2.2.2 Button/Switch Types	- 18 -
2.2.3 Sub-Trim Button	- 19 -
2.3 Technical Specifications	- 20 -
2.4 LED Indicator Definition	- 22 -
3 GET READY TO USE DK32S	- 23 -
3.1 How to Place Transmitter Antenna Right	- 23 -
3.1.1 Good Antenna Angle of Transmitter	- 25 -
3.1.2 Good Antenna Angle of Air Unit	- 26 -
3.2 How to Charge DK32S Transmitter	- 27 -
3.3 How to Link/Bind DK32S Transmitter to DK32S Air Unit	- 28 -
3.4 Throttle Joystick Type	- 30 -
4 MAIN MENUS	- 32 -
5 MODEL SETTINGS	- 34 -
5.1 Channel Monitor	- 36 -
5.2 Model Select	- 36 -
5.2.1 Select a Model	- 36 -
5.2.2 Rename a Model	- 37 -
5.2.3 Copy a Model	- 39 -
5.2.4 Reset all Models	- 40 -

5.3 Model Type	- 41 -
5.3.1 How to Select a Model Type	- 41 -
5.3.2 One Move to Do Agricultural Drone Settings	- 42 -
5.4 End Point	- 44 -
5.5 Channel Mapping	- 45 -
5.6 Channel Reverse	- 49 -
5.7 Sub-Trim	- 50 -
5.8 Trim Settings	- 52 -
5.9 Trainer Mode	- 54 -
5.9.1 Steps through Using Trainer Cable	- 55 -
5.9.2 Steps of Wireless Trainer	- 56 -
5.10 Fail Safe	- 58 -
5.11 Timer	- 60 -
5.12 Voltage Alert	- 61 -
5.13 Farming Voice	- 62 -
5.14 Joystick Dead Zone	- 64 -
5.15 Multi-Drone Control	- 65 -
6 SYSTEM SETTINGS	- 67 -
6.1 General Settings	- 69 -
6.2 Screen Lock & Display	- 70 -
6.3 H / W Settings	- 71 -
6.4 Extending Ports Settings	- 73 -
6.5 Joystick Calibrating	- 75 -
6.6 LD Calibrating	- 77 -
6.7 Export/Import Setting Data	- 78 -
6.8 Power Ratio	- 80 -
6.8.1 RF Power	- 81 -
6.8.2 Transmitter/Sky Station Antenna	- 81 -
6.9 ESC Cali	- 83 -
7 Sky Station Settings	- 84 -
7.1 General Settings	- 85 -

7.1.1 Signal Mode	- 85 -
7.1.2 Automatic Linking	- 86 -
7.1.3 Voltage Telemetry	- 86 -
7.1.4 Remote Control Relay	- 86 -
7.2 Voltage Calibrating	- 87 -
7.3 PWM Settings	- 88 -
8 Video Transmission / Datalink Settings	- 90 -
8.1 Basic Settings	- 91 -
8.2 Advanced Settings	- 92 -
8.3 Bluetooth	- 93 -
8.4 Link Status	- 93 -
8.5 Video Transmission Settings	- 94 -
8.6 Navigation Light	- 94 -
9 Firmware Upgrade	- 95 -
10 After-sale Service	- 99 -
8.1 Repair Service	- 100 -
8.2 Warranty	- 100 -
8.2.1 7-Day Return & Refund	- 101 -
8.2.2 15-Day Replacement	- 102 -
8.2.3 1-Year Warranty Repair	- 103 -

1 READ TIPS

1.1 Icon Definition

Please pay more attention to content indicated with the following marks:

 **DANGER** Dangerous manipulation probably leads to human injuries.

 **WARNING** Warnings on manipulation possibly leads to human injuries.









 **CAUTION** Cautions on what manipulation may lead to property loss.

 **Prohibited**  **Mandatory**  **Mark**

1.2 Flight Safety

DK32S Radio System is designed for professional application in specific industries, users who approaches to the device should have at least the basic ability to manipulate it. Any irregular or irresponsible manipulations of the device may cause damages and lead to property loss or human injuries. Non-adult users must follow their trainer's guidance or the supervision of any adult. Disassembling or modification on the system is prohibited without the permission from SIYI Technology.

To maintain a safe and orderly public space and to ensure you a good using experience of SIYI's products, please read the prohibited and mandatory terms carefully:

-  Do not use DK32S Radio System to control an aircraft in places of intensive crowd (squares, parks), places of many obstructions (streets, parking lots), fields of strong magnetic or interference (power/radar stations, railways) or any other fields that may cause property loss or human injuries.
-  Do not hold or cover transmitter antenna or obstruct transmission by any mean in a flight.
-  Do not point directly to your aircraft with the sky station antennas' upper end in a flight.
-  Do not fly an aircraft when you are tired, drunk, sickness or in any occasion without a good feeling.
-  Do not fly an aircraft when it is rainy, windy or at night.
-  Do not power off the transmitter in a flight while the aircraft engine and motors are still working.
-  Keep the aircraft within sight range in a flight.
-  Make sure the DK32S transmitter's screen menu is back to system menu before taking off a flight, in case of any accident caused by mistouching to system settings.
-  Do not forget to check both battery levels of the transmitter and the sky station before flying an aircraft.

- ❗ Before finishing flight, power off the aircraft first, then the transmitter.
- ❗ Before doing any setting or adjustment to the transmitter, make sure the aircraft engine is powered off and motor wires are off connection, in case of an accidental power-on.
- ❗ Before fly an aircraft for the first time, make sure that the fail-safe function in the DK32S transmitter is activated.
- ❗ Before fly an aircraft for the first time, power on the transmitter first and hold the throttle joystick at its bottom position, then power on the aircraft.

1.3 Precautions on Charging

DK32S transmitter is equipped with a built-in Li-Po 1S rechargeable battery, compatible with standard USB chargers (5V/2A output) in market.

Considering there are many different types of chargers, please read the prohibited and mandatory carefully before charging DK32S transmitter.

- ⊘ Do not use any USB chargers over 5V output to charge DK32S transmitter.
- ⊘ Make sure DK32S transmitter is powered off before charging. And the charging current should not exceed 2A.
- ⊘ Stop charging if you find the charger is damaged, broken or overheated.
- ⊘ Stop charging if you sense a peculiar smell, smoke or leak, and sent the transmitter back to SIYI Technology for detection and testing.

 Do not charge DK32S transmitter when the environment temperature or the battery temperature is over 60°C.

DANGER

Keep DK32S transmitter away from any places that a baby or a kid may reach while you are charging it, and it could be better if there are supervision of any adult in case of accidents.

1.4 Precautions on Using SD Card

 Do not disassemble, bend, press, abandon or damage SD card by any means.

 Stop using the SD card if you find it soaked by water, oil or any other chemical liquid.

CAUTION

A SD card is also an electronic product, keep it away from static electricity.

Keep the Micro-SD card slot clean in case of blocking by sand or dirt.

Keep the SD card in slot while you are downloading or uploading data; taking out it mistakenly, hitting it or shattering it may cause damage or data loss.

Keep the SD card away from places that a baby or a kid may reach in case that it was swallowed mistakenly by the baby/kid.

1.5 Precautions on Storage/Carrying/Recycling

CAUTION

Keep DK32S transmitter away from any places that a baby or a kid may reach when you are placing or storing it.

DANGER

Please avoid placing or storage DK32S Radio System in places below:

Places are extremely hot (above 60°C) or cold (under -20°C);

Places with direct sunshine, places are too dusty or wet;

Places with an unstable structure or may cause vibration;

Places near steam or other heat sources.

2 PRODUCT INTRODUCTIONS

2.1 Product Features

Advanced Spread-spectrum Technology

DK32S Radio System is applied with SIYI Technology's latest bidirectional 2.4GHz spread-spectrum technology. Maximum control range can be up to 20km (unobstructed, free of interference). DK32S transmitter and its Air Unit are linked by a unique matching code. The system comes with enhanced anti-interference performance and supports multiple transmitters working in stability synchronously.

Extraordinary Handling & Accurate Manipulating Experience

DK32S transmitter fits users' palm, fashionably streamlined, and compact industrial design.

16-Channel Fast-Response Mode

DK32S transmitter is equipped with various types of buttons, dials, and switches. 16 channels support all kinds of models, including aircrafts, helicopters, gliders,

quadcopters, multi-rotors, and major agriculture/commercial drones on market.

20KM Super Long-Distance Datalink, Real-Time Telemetry

DK32S' control range can reach 20 kilometers*, which covers business flight range of most agriculture/commercial drones. A perfect mate for BVR (Beyond Visual Range) flying.

In the built-in screen of DK32S transmitter, it displays real-time telemetry of Air Unit voltage, battery voltage, RF signal strength, information of the GPS module, and other multi-sensors.

*Tested in an unobstructed and free of interference field.

Voice Broadcast with Vibration Alert

Voice broadcast with vibration alert help users be more concentrated on flying.

High Brightness Colorful LCD Touch Screen, Brand New GUI System

DK32S transmitter's high brightness colorful screen is clearly visible under direct sunlight. Few complicated keys and buttons, but a built-in LCD touchscreen, with a turntable menu and a brand-new GUI system. These revolutionary new features made by both software and hardware provide a more user-friendly experience.

Creative 5-Dimensional Sub-Trim Buttons

Sub-Trim button design on traditional transmitters have been overturned on DK32S transmitter, now you are able to do quick adjustment between sub-trim buttons and joysticks in flight. The sub-trim buttons are made of elegant aluminum alloy, CNC molding, along with a unity industrial design, extraordinary operating experience.

Fulfils the Requirement of Complicated Models or Robotics

- In default, DK32S transmitter can save up to 64 groups of data storage, the amount can be extended to limitless if necessary.
 - Powerful programming and mixing, various and customized linear/curve mixing.
 - Adjustable rate, editable throttle curve, and pitch curve, to be complied.
 - Data copy function provides convenience to users for sharing their transmitter configurations easily with friends.
 - Under trainer mode, two transmitters can work synchronously, one for trainer, the other for trainee. And there is various protection. For instance, the master transmitter can take control flying over the slave transmitter.
 - Channel mapping function supports customize channel definition.
- Fail-safe function provides more security to flight safety.

Built-in High-Capacity Li-Po Battery

DK32S transmitter comes with built-in high-capacity Li-Po 1S rechargeable battery, reliable and easy to be maintained. Through Micro-USB port, you can charge the

transmitter. DK32S transmitter runs continuously for more than 12 hours after full charging. You won't have to worry about long-time flight outdoors.

SD Card Data Saving and Transfer

DK32S transmitter supports saving/copying/transferring model configuring data through an SD card.

PC Software

DK32S Radio System supports firmware upgrade and some configuring on PC with "SIYI Assistant" software. SIYI think it as an obvious promotion to user experience promises continuous service and to add cool and new features in the future.

2.2 Parts

2.2.1 At a Glance

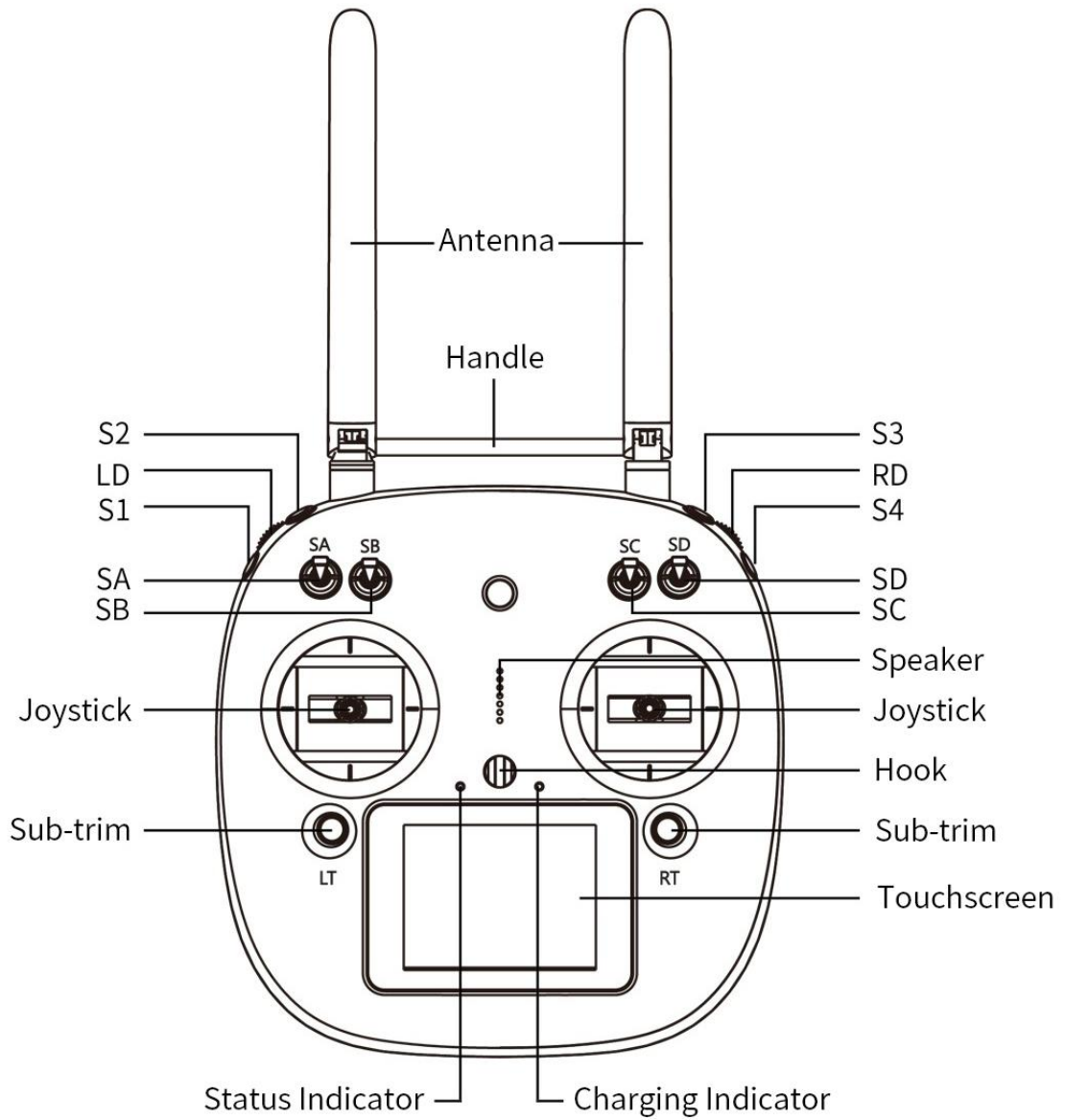

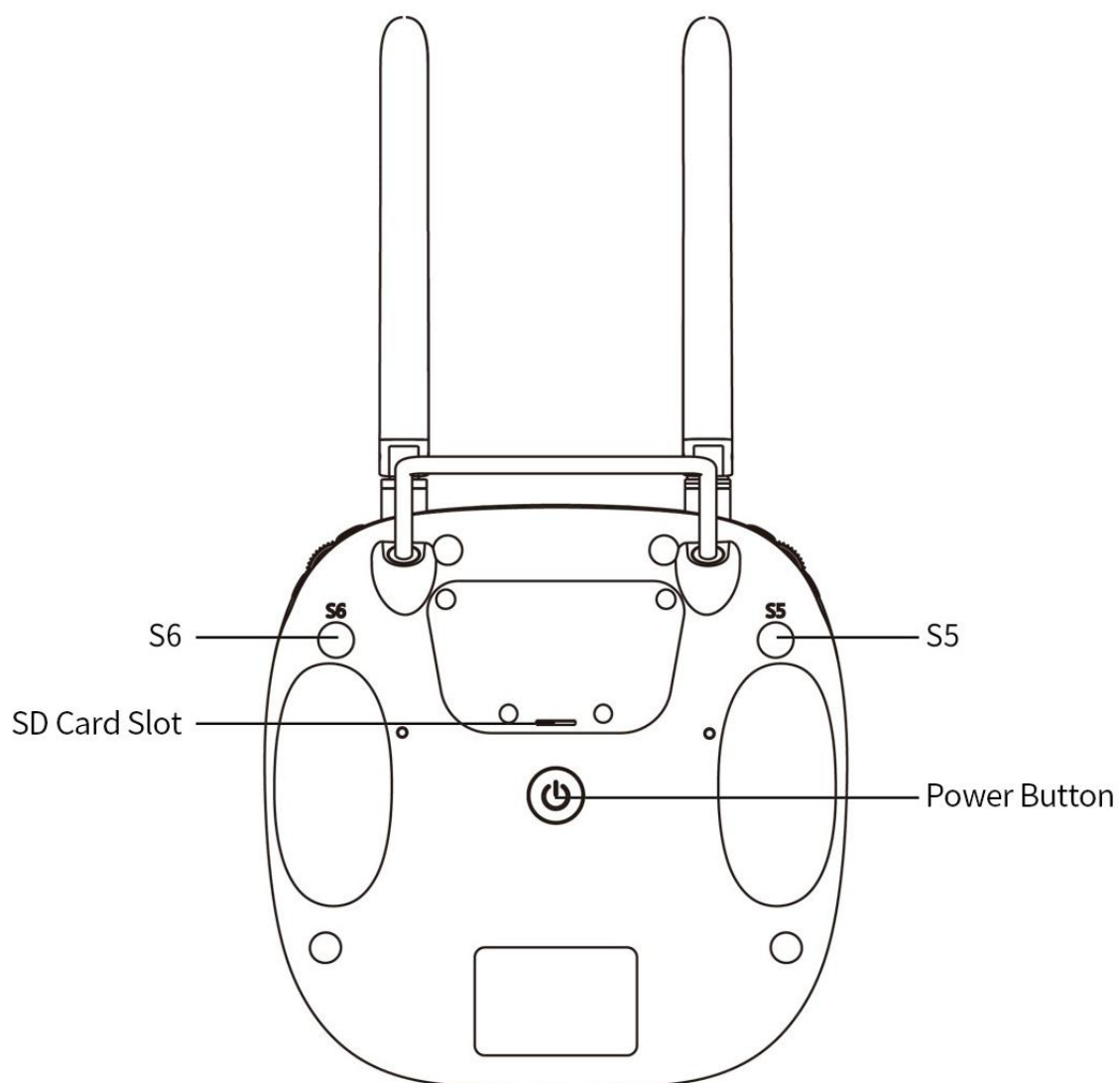

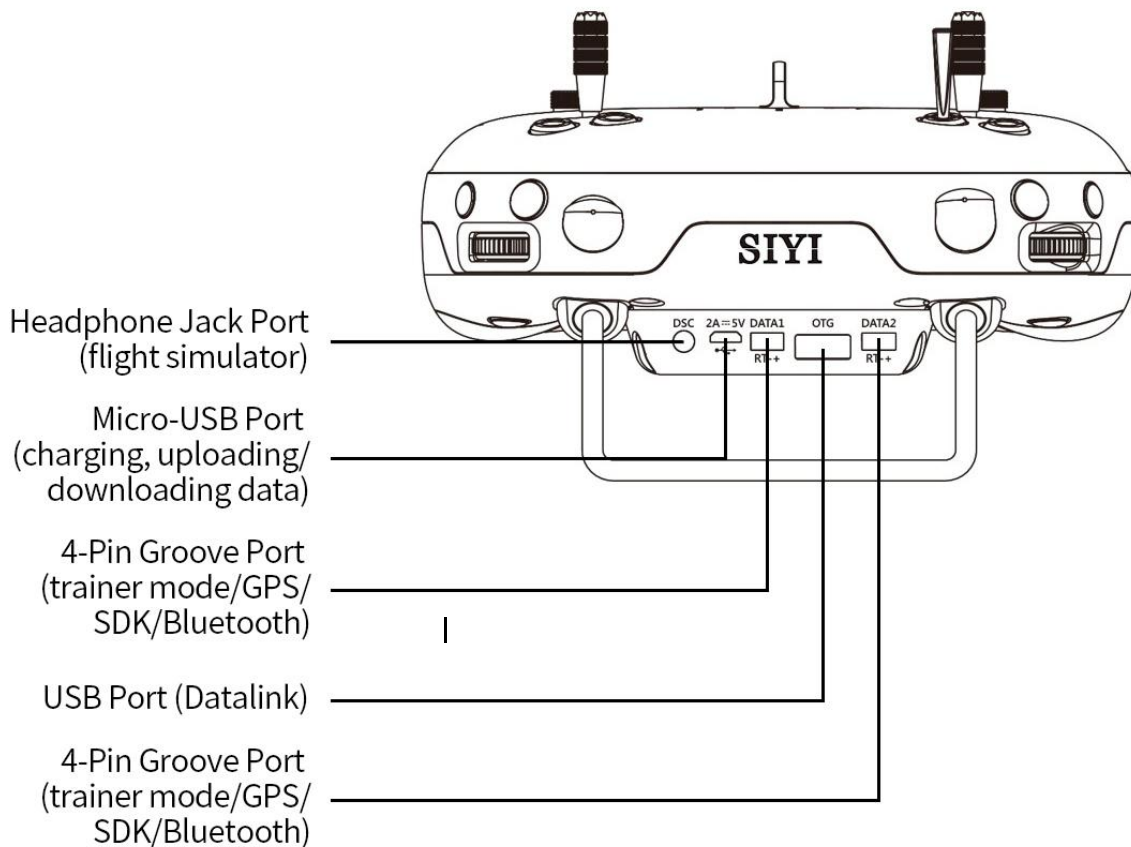

2.2.2 Button/Switch Types

Name	Type
SA	3-stage Switch
SB	3-stage Switch
SC	3-stage Switch
SD	3-stage Switch

LD	Self-centering Dial
RD	Thumb-slide Dial
S1	Self-resetting Button
S2	Self-locking Button
S3	Self-locking Button
S4	Self-resetting Button
S5	Self-resetting Button
S6	Self-resetting Button

Mark: Self-locking button stays in the depth you press them to, while self-resetting button bounces back.

2.2.3 Sub-Trim Button

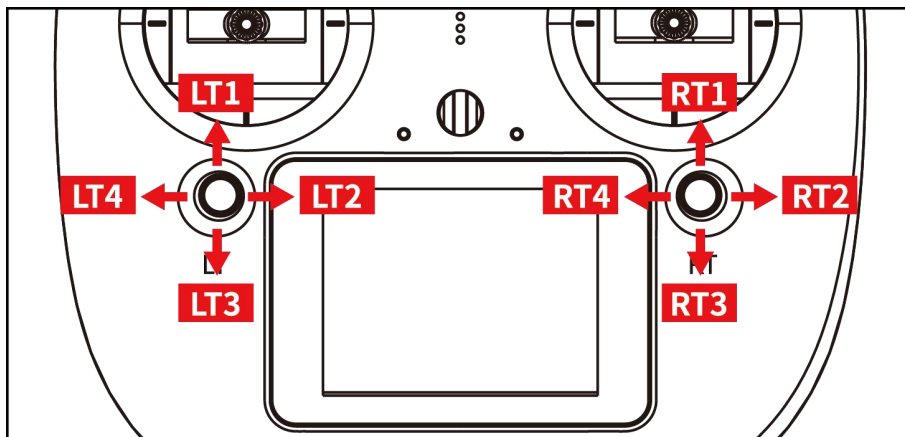

- There are 2 Sub-Trim buttons on DK32S transmitter, which support continuous trimming to all 4 channels.

- Each Sub-Trim button has 2 dimensions (up-down, left-right) for direct trimming settings to mapped channels.
- Every pushing on Sub-Trim button leads to a small change from previous position at default stepping value. Keep pushing on the button will speed up changing. There will be different alerting sounds when Sub-Trim button is in middle position.
- Sub-Trim position changes are displayed as dynamic animation in system menu.

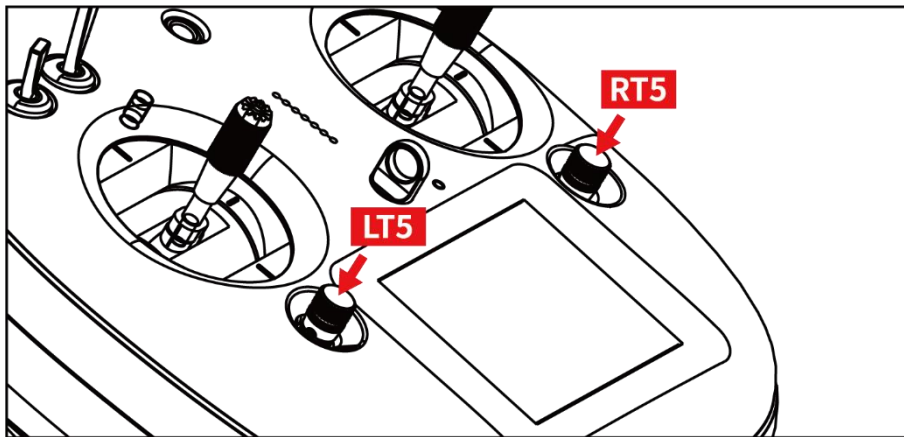

- Sub-Trim buttons can also be used to unlock screen menu when transmitter lock is activated. Press and hold left/right Sub-Trim button to unlock transmitter.
- Mark:** Please refer to “Sub-Trim Settings” menu to do configuration of Sub-Trim button.

2.3 Technical Specifications

Channels	16 Physical Channels, 16 Communication
-----------------	--

	Channels
Supported RC Model	Planes / Copters / Gliders / Multi-rotors / Vehicles / Boats / Robotics
Data Storage	64 groups of configuring data, and expandable
Language Display	Chinese / English
Joystick Resolution	4096 grades
Frequency Band	2400 ~ 2483 MHz
Receiving Sensibility	-101 dBm
Transmission Distance	Maximum 20 kilometers (unobstructed, free of interference)
Display Screen	2.8-Inch High-Brightness Colorful LCD Screen, Resolution 240 x 320
Screen Type	Capacitive touch screen
Battery Type	Built-in 3.7 V 5000 mAh Li-Po 1S battery
Working Current	270 mA
Battery Life	12 hours
Charging Port	Micro-USB port
Product Dimension	194.5 x 172.5 x 114 mm
Product Weight	610 g

2.4 LED Indicator Definition

On DK32S transmitter, there are two LED indicators. The left one is Status Indicator, the right one is Charging Indicator.

- Status indicator displays transmitter's RF status.
- Charging indicator displays transmitter's charging status.

Status Indicator Definition

- Solid Red: RF transmitting is off.
- Solid Green: RF transmitting is on.

Charging Indicator Definition

- Solid Red: Transmitter in charging.
- Solid Green: Charging finished.

3 GET READY TO USE DK32S

3.1 How to Place Transmitter Antenna Right

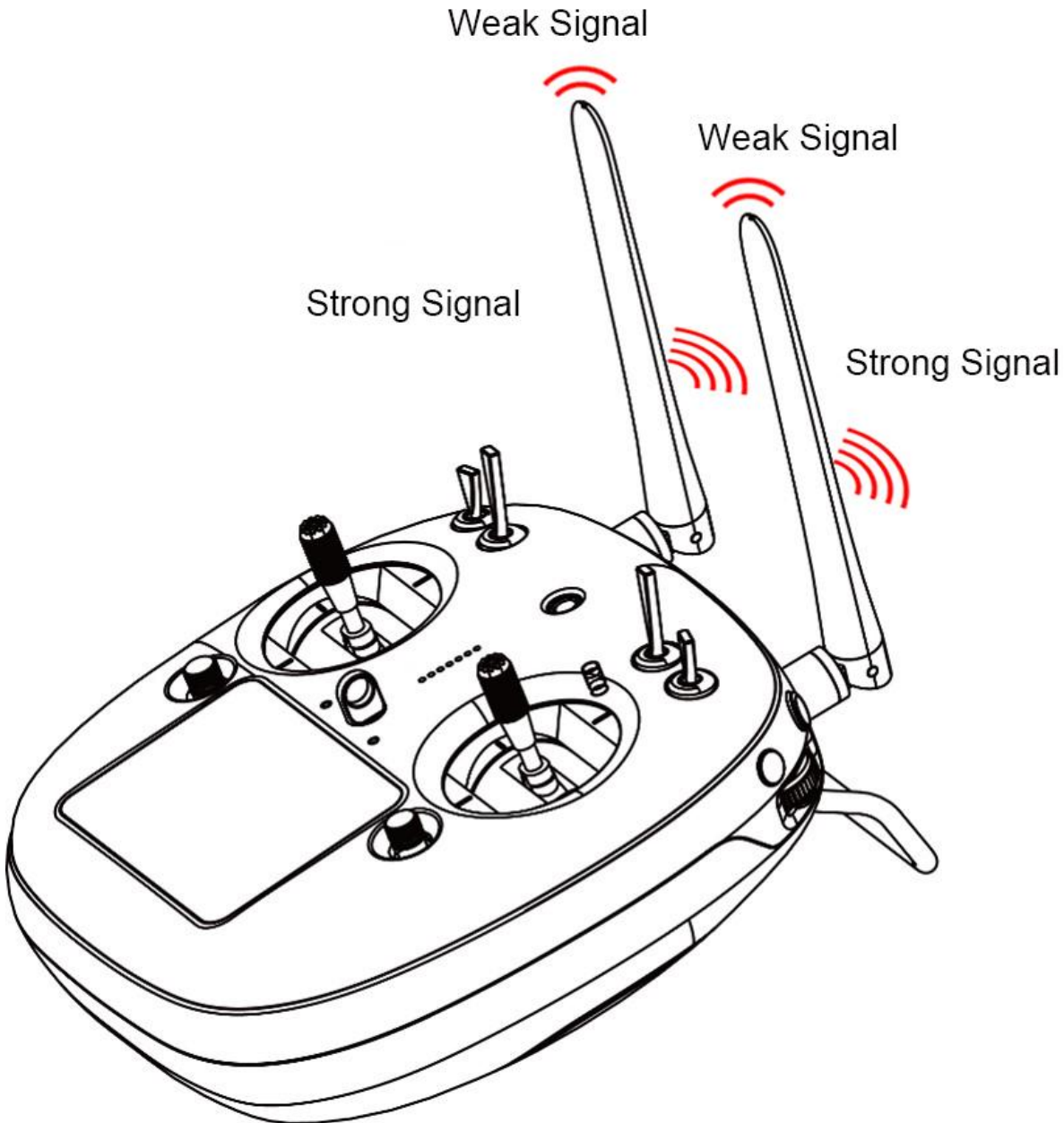

A

Mark: DK32S has the best signal strength when they are placed horizontally. Thus, please avoid pointing antennas' upper end straightly to your aircraft and do not fold the antennas.

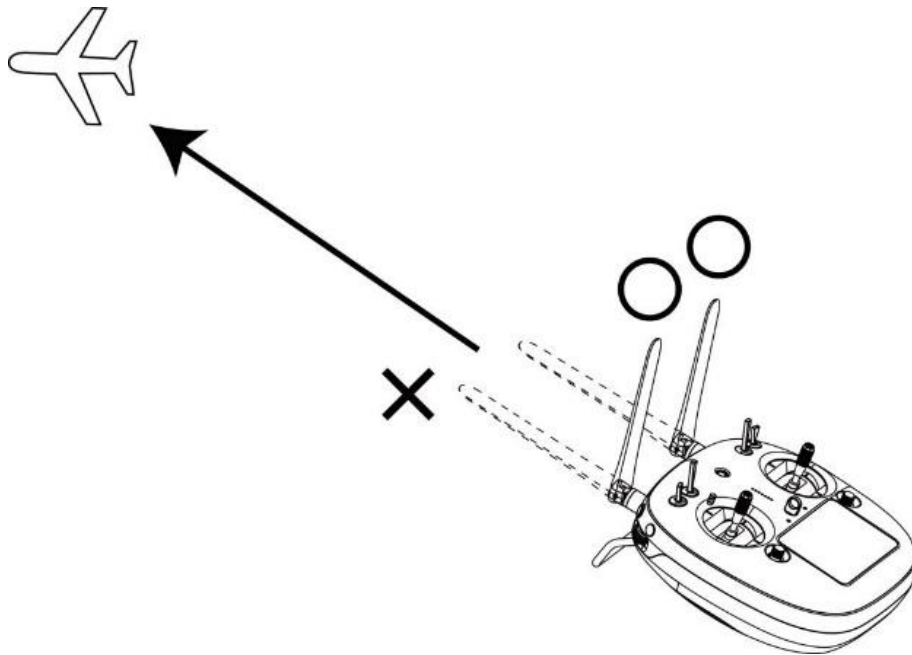

B

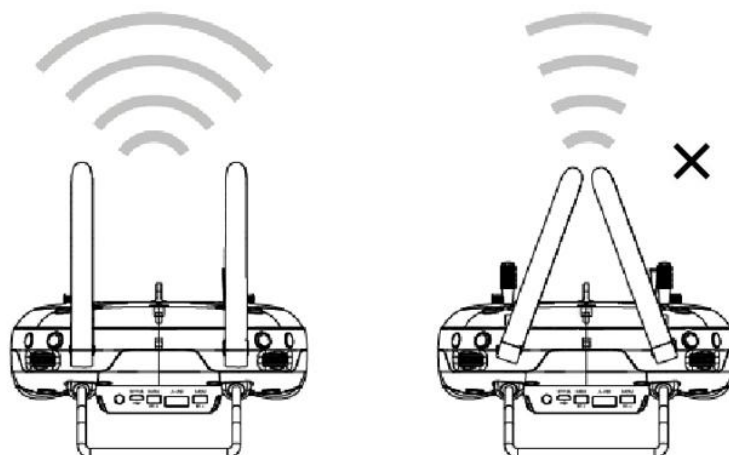

C

3.1.1 Good Antenna Angle of Transmitter

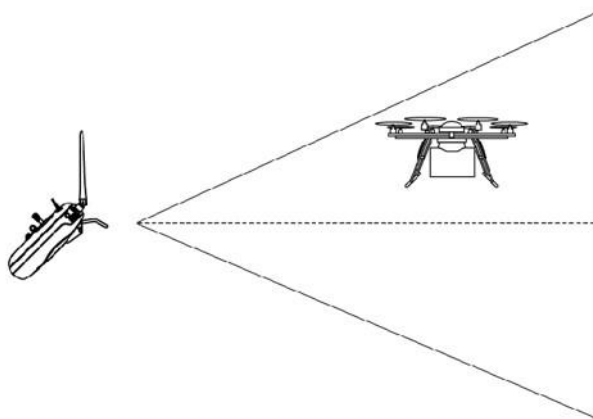

Aircraft in front of the transmitter

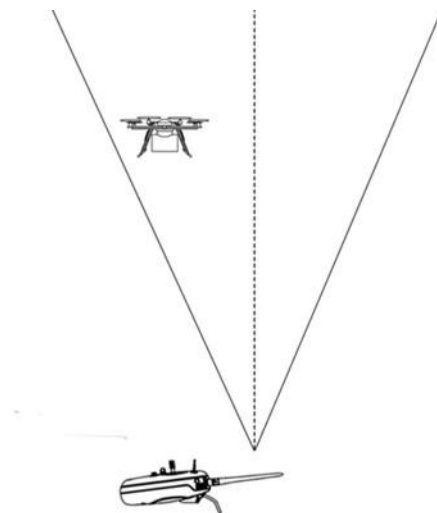

Aircraft above the transmitter

3.1.2 Good Antenna Angle of Air Unit

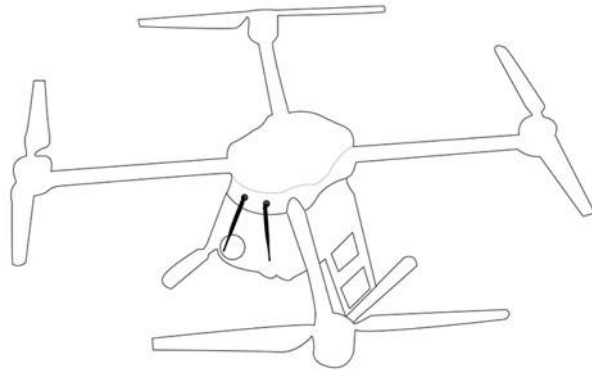

Flying high

(Altitude higher than 10 meters, **antennas should be placed downwards**)

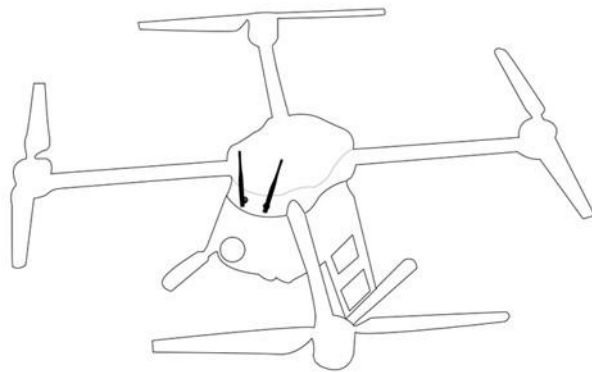

Flying low

(Altitude lower than 10 meters, **antennas should be placed upwards**)

! WARNING

Do not fold or cover antennas and avoid any obstruction between the transmitter and the aircraft in flight, otherwise there will be an obvious decrease to transmission signal quality.

3.2 How to Charge DK32S Transmitter

Before charging the DK32S transmitter, please read the part “1 READ TIPS - 1.3 Precautions on Charging” carefully.

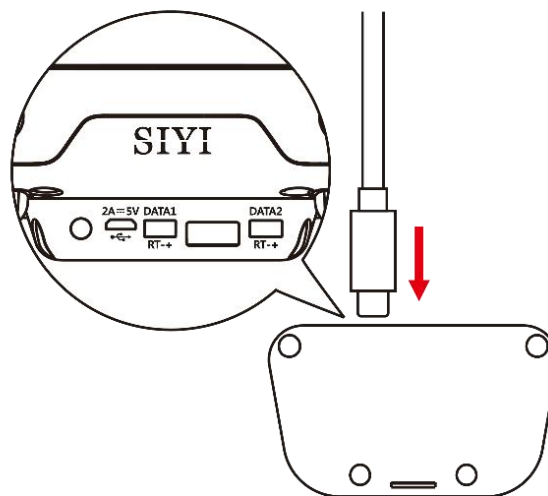



Please use original OTG Micro-USB cable coming in DK32S packing list to plug into the Micro-USB port on transmitter and the USB charger.

- Mark: Please power off transmitter before charging.
- Mark: Please make sure that charging current is less than 2A or it may cause damage to battery.

 Mark: DK32S transmitter is equipped with a built-in 5000mAh LiPo 1S battery. Charging time is about 5 hours using a standard **5V/2A** charger adapter. Charging time may change according to chargers made under different standards, please also pay an attention to the charging indicator when you are charging the transmitter.

Charging Indicator Definition

Power Off Charging

-  Solid Red: Transmitter is under charging.
-  Solid Green: Charging is finished.

3.3 How to Link/Bind DK32S Transmitter to DK32S Air Unit

Each unit of the DK32S transmitter is assigned with a unique ID code. Before linking DK32S transmitter to DK32S Air Unit, the Air Unit identifies transmitter ID (**Linking/Binding**) first. After the first linking process between transmitter and Air Unit, the ID code will be memorized in the Air Unit so that you don't have to repeat the process before the next flight/operation (except when your transmitter must be linked with a different Air Unit).

Linking/Binding Steps

1. Please keep your DK32S transmitter one meter away from your Air Unit and power on both;

2. In transmitter screen menu, tap on “System Settings – General Settings”;

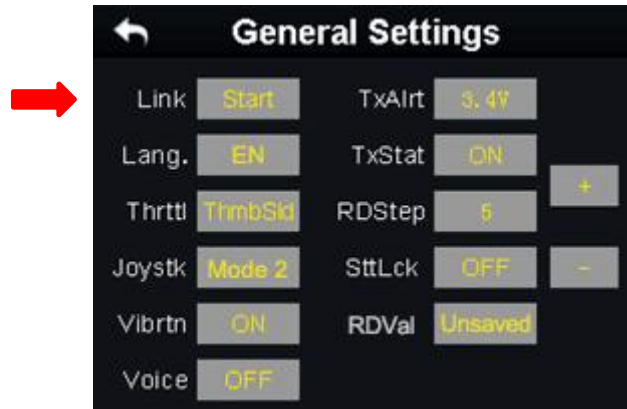

3. Turn to the Air Unit, stick a pin or needle to the linking button inside the linking hole, press and hold the button for 3 seconds till the status indicator blinks red which means the Air Unit is ready for linking;

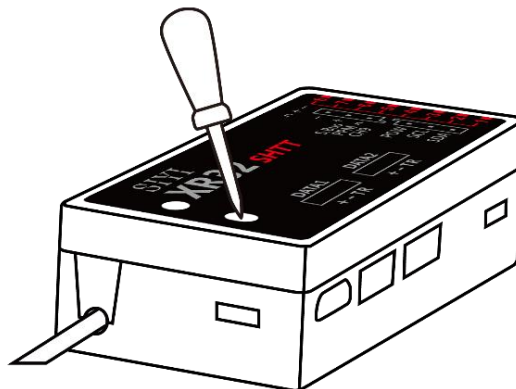

4. Tap on “Link - Start” and wait for a second, if transmitter indicator and Air Unit indicator both blink green, linking is finished.

! WARNING

Before linking transmitter to Air Unit, please make sure your aircraft motors have no power supply (E.S.C are off connection).

Re-power Air Unit when linking steps are finished, and try to manipulate on transmitter to confirm if it works well.

3.4 Throttle Joystick Type

DK32S transmitter supports both “Thumb-slide” and “Self-centering” throttle joysticks. Users decide which type to use according to their preference. Generally, if your DK32S transmitter has been set up as “Thumb-slide” throttle joystick, then the throttle type in “System Settings” should be “Thumb-slide” as well.

Thumb-slide Joystick: While users are powering on the transmitter, it alerts with voice broadcast if the throttle joystick is not in its bottom position, and disables RF transmitting automatically (the transmitter status indicator is off). The transmitter will not enable RF transmitting until throttle joystick was back to the bottom position.

Self-centering Joystick: No alert, the transmitter works normally.

Steps

In “System Settings” menu, tap on “General Settings - Throttle – Thumb-slide / Self-centering” to choose your favorite throttle type.



4 MAIN MENUS

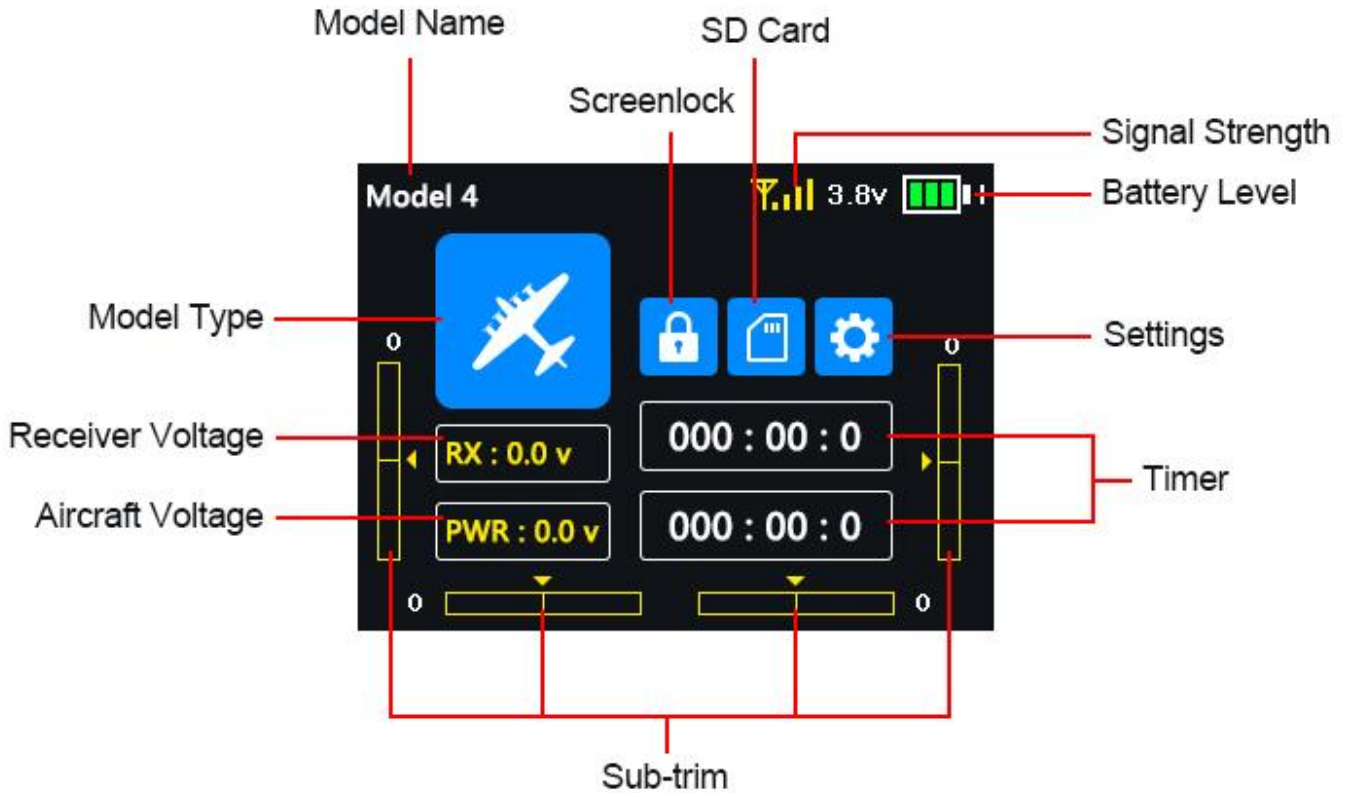

Model Name

Displays the name of the selected model.

Model Type

Displays the selected model type.

Battery Level

Real-time monitoring of VD32 transmitter's battery level.

Settings

Approach to the "Transmitter Settings" menu.

Air Unit Voltage

Real-time display of the sky station's voltage telemetry.

Aircraft Voltage

Real-time display of the aircraft's voltage telemetry.

Sub-trim

Displays the digital sub-trim value of all 4 channels.

Screen Lock

The main menu is locked, the touchscreen is disabled (the icon disappears when main menu is unlocked).

SD Card

A SD card is inserted in VD32 transmitter (the icon disappears when the SD card is taken out).

Timer

Displays maximum two timers as to assist users with the flight.

Signal Strength

Real-time displays of the RF transmitting signal quality.

5 MODEL SETTINGS

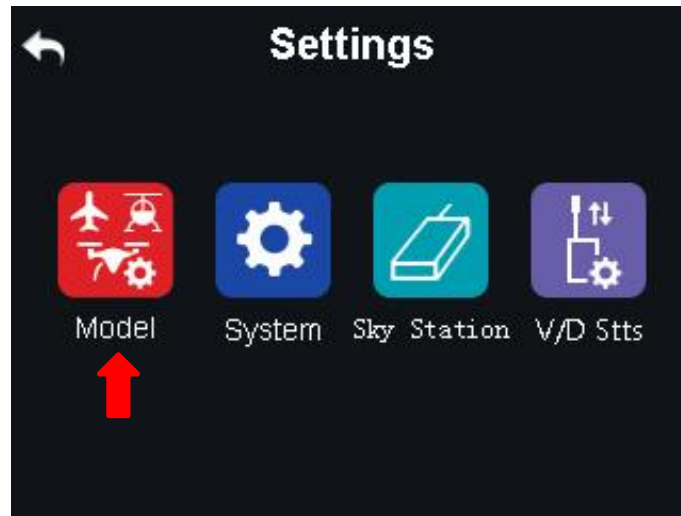

In DK32S transmitter’s “Model Settings” menu there are a series of useful functions, offering basic and advanced settings for different kinds of model devices.



CH Monitor (Channel Monitor)

Real-time display of all channels’ output value.

Model Select

Select / Save model data.

Model Type

Choose the right model type for your device.

End Point

Set the output values of a channel and the maximum / minimum limit.

CH Mapping (Channel Mapping)

Set / Change the defined function of a channel.

CH Reverse (Channel Reverse)

Reverse a channel's output direction.

Sub-trim

Do trim adjustment to your aircraft's flight attitude.

Trim Setting

Adjust the stepping value of the sub-trim function.

Trainer Mode

One on one training through two transmitters.

Fail Safe

Adjust fail safe settings.

Timer

Turn on / off the timer.

LowVol Alert (Low Voltage Alert)

Low power alert of the aircraft battery.

Special Function for Agricultural Drones

Farm. Voice (Farming Voice)

Real-time voice broadcast specialized for agricultural drones.

JstkDeadZone (Joystick Dead Zone)

Filter mistaken manipulation caused by touching joysticks unintentionally.

MultiDroCtrl (Multi-Drone Control)

Control the flight of up to three drones at the same time through one transmitter.

5.1 Channel Monitor

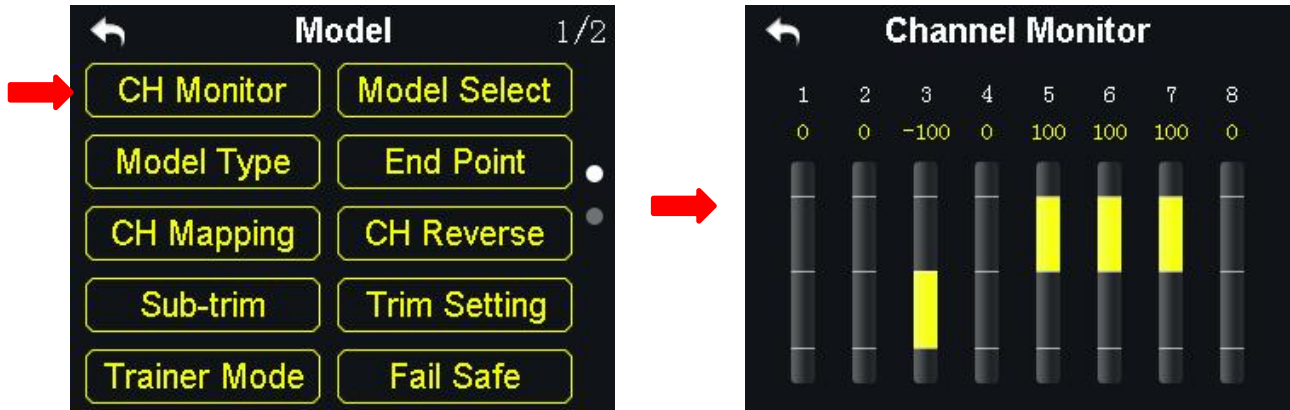

Channel Monitor page is for real-time monitoring and configuring output values of all 16 communicational channels.

5.2 Model Select

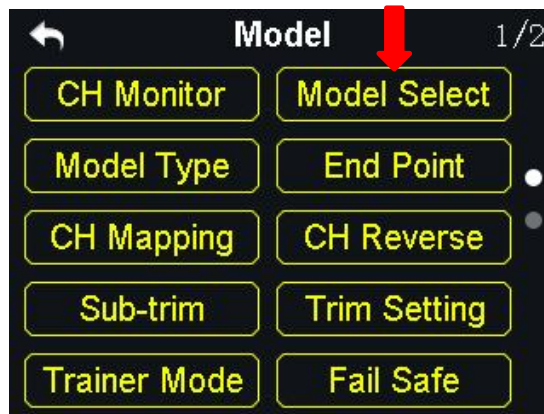

Model Select page is for users to select, rename, copy, and reset model data.

5.2.1 Select a Model

FT24 transmitter-trim supports up to 64 storage groups for saving and selecting data.

Steps

1. Go to “Model Select” page.

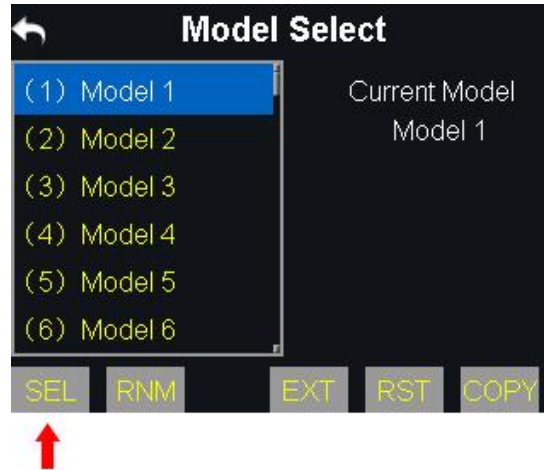

2. Tap on a model, then “SEL(Select)”. It comes “Confirm your selection”, tap on “Yes” to finish selecting.

5.2.2 Rename a Model

Users can rename a group of model data to make difference. And the selected model name displays in transmitter menu.

Steps

1. Tap on a model name, then “RNM(Rename)”. It comes “Confirm renaming”. Tap on “Yes”, it comes a virtual keyboard menu.

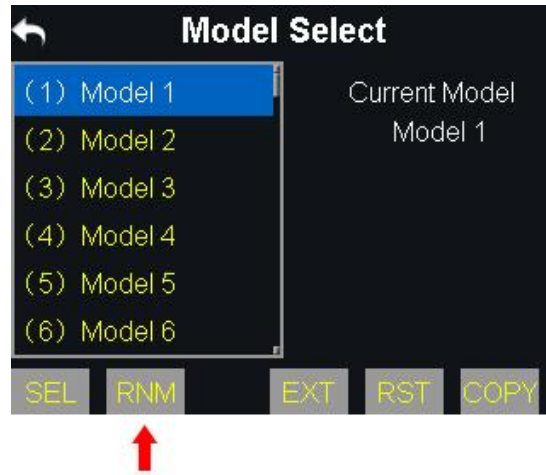

- Input a new name for the model by using the virtual keyboard, then tap on “yes” to finish.

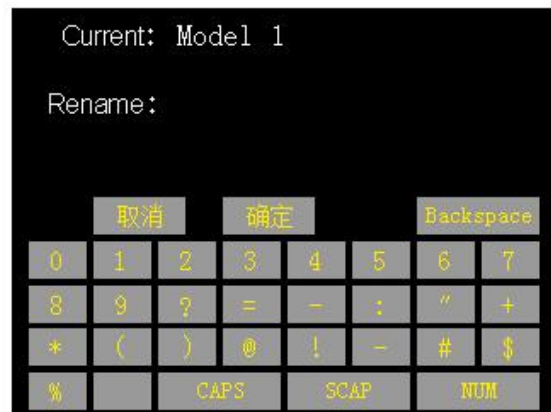
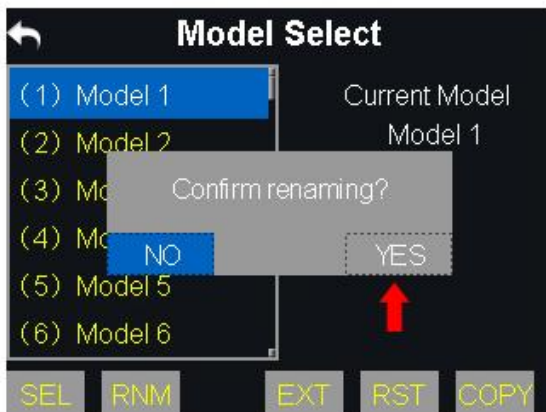

About Virtual Keyboard

CAPS

Switch keyboard to input capital letters.

SCAP

Switch keyboard to input lower case letters.

NUM

Switch keyboard to input numbers and punctuations.

Backspace

Delete what is already input.

Cancel

Cancel inputting, the transmitter will not save the input.

5.2.3 Copy a Model

Users can copy a model data for backup and easy sharing.

Steps

1. Tap on a model name, then “Copy”. It comes “Copy a Model”.

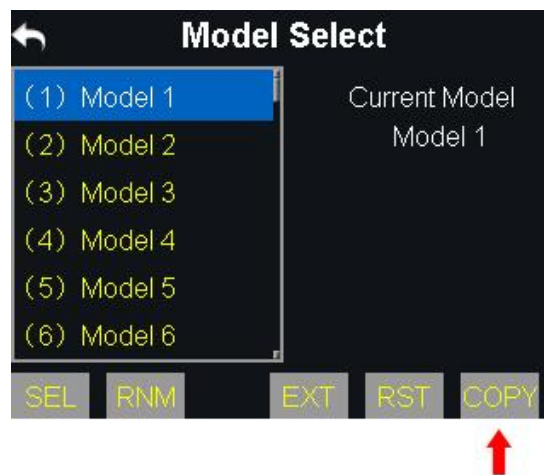

2. Select the target model on the turntable, then tap on “Yes” to finish.

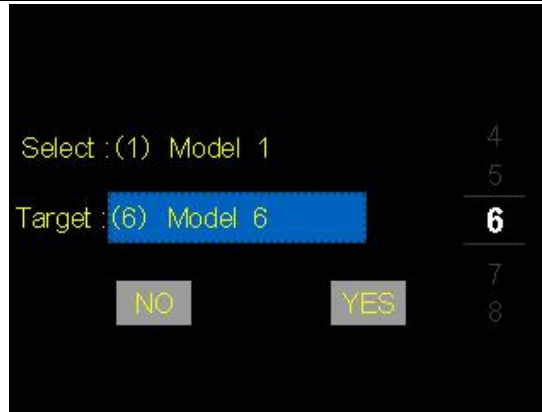

5.2.4 Reset all Models

Reset is to clear all saved data in the model list to the default settings.

Steps

1. Tap on “Reset”, it comes “Confirm to reset”;

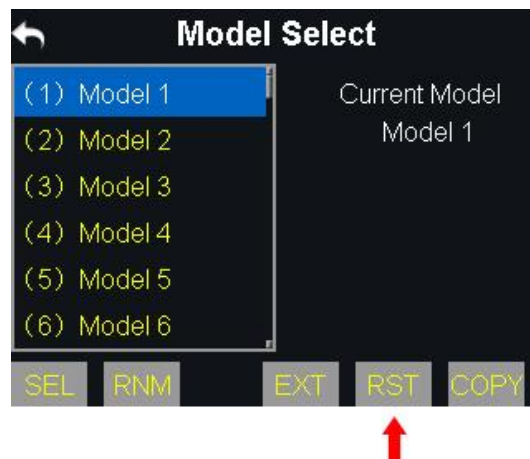

2. Tap on “Yes” to finish.

5.3 Model Type



In the DK32S transmitter there are several default model types, Fixed-wings / Gliders, Multi-rotors (racing drones, agricultural drones) and the others (helicopters), each model type with its default settings done in advance. Users can choose a model type according to their requirement and customize the settings.

CAUTION

When you switch a model type, all the data in the current model will be reset automatically.

It is better to save the model data before switching to another model type.

5.3.1 How to Select a Model Type

Steps

1. In the “transmitter settings” menu, tap on “Model Settings - Model Type”;
2. In the screen, it displays the current model type; tap on it, in the screen it is switched to the “Model Type” list;

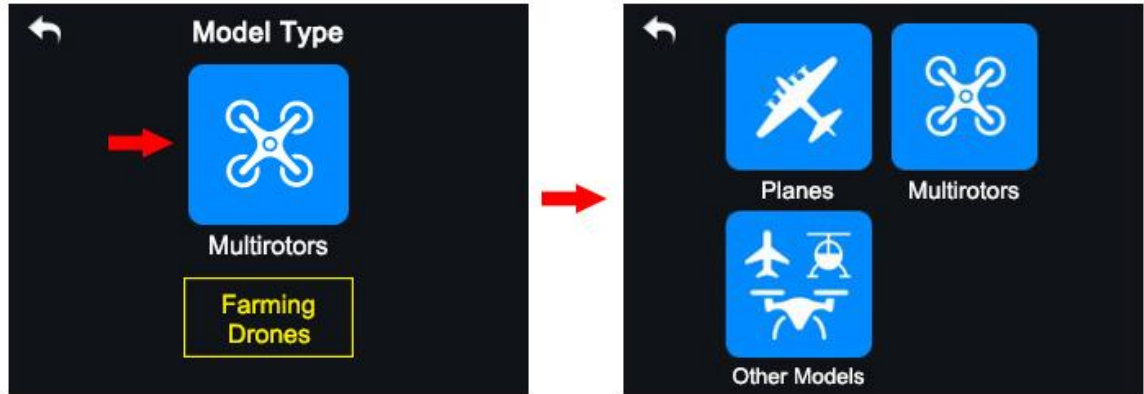

3. Tap on a model type according to your requirement, then “Apply” to finish.

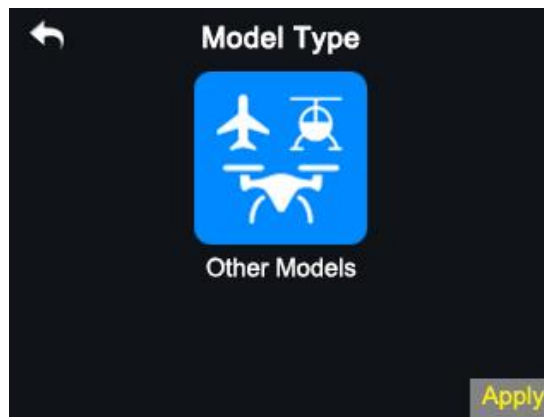

5.3.2 One Move to Do Agricultural Drone Settings

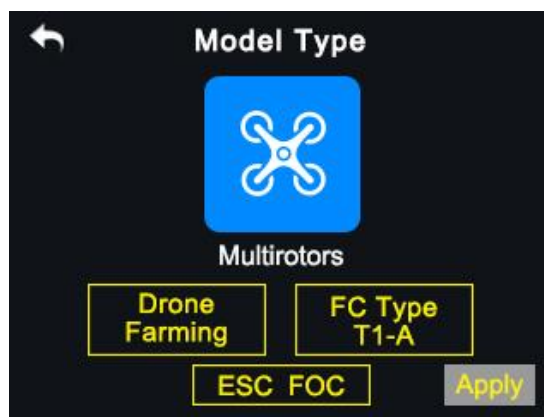

Through the DK32S transmitter users can finish agricultural drone settings easily. Users just pick a FC(Flight Controller) type and an ESC(Electronic Speed Controller) type according to what they have bought, then the

switch/button/joystick definition settings, voice broadcast and datalink function settings will be finished automatically.

CAUTION

Make sure the transmitter and the sky station are linked before doing agricultural drone settings.

When the settings are finished, do not forget to calibrate the transmitter joysticks before unlocking motors and taking a flight.

Steps to Do Agricultural Drone Settings

1. In the model settings menu, tap on “Model Type”, in the screen it shows the model type menu;
2. Choose “Multi-rotors” as the model type, “Farming Drone” as the drone type, and the FC and the ESC type according to what you have bought; then tap on “Apply” to finish;
3. Calibrate the transmitter joysticks in the ground station of the flight controller and finish the Fail-safe settings, then you will be ready for unlocking motors and taking a flight. (Please watch the tutorial videos for more detail: <http://siyi.biz/cn/DK32S/video/>)

5.4 End Point

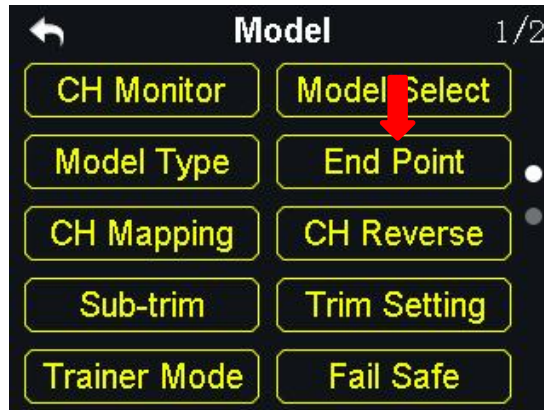

“End Point” page helps users configure channel output value and output limit.

Steps

1. Go to “Model” page, tap on “End Point”.
2. The page displays information as in the picture below. “- E. P. A +” stands for the channel value, “-limit / limit+” stands for the minimum/maximum limit value);

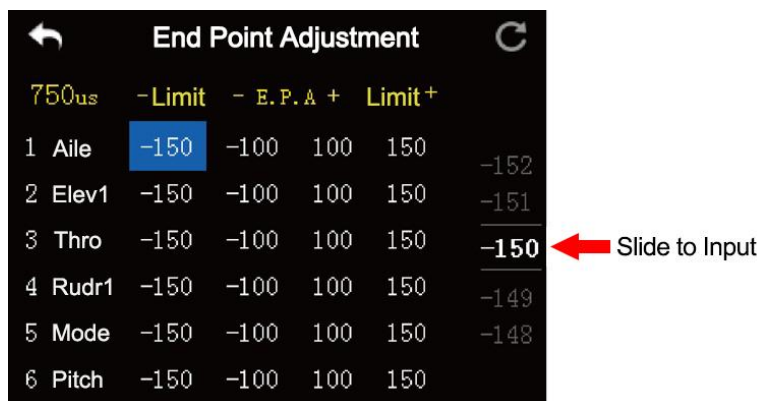

3. Select a channel and its output value, press the “+” or “-” button on transmitter to adjust value or limit (-150 ~ 150).

4. After configuring, channel output value does exceed the limit even under “Programing and Mixing*” mode, which protects servo and other external devices.

Mark: In “End Point” page, the icon at up-right corner is for resetting all channel values.

5.5 Channel Mapping

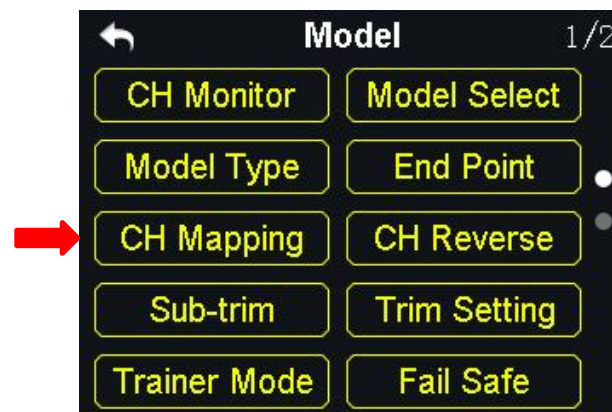

All 16 channels in FT24 transmitter can be mapped freely to joysticks, switches, buttons, and dials.

Steps

1. Go to “Model” page, tap on “CH Mapping”.
2. The page displays information as in the picture below. Tap on middle boxes will lead to a list of all joysticks, switches, buttons, and dials.



3. In default, channel 1-4 is to be Aileron, Elevator, Throttle, and Rudder.
4. Let's take example. If you are to re-map Channel 1 (Aileron), enter CH1's middle box on and select a joystick/switch/button/dial.
5. Tap on right boxes will lead to a list of trimming switches. Repeat step 4 to re-map a trimming switch.

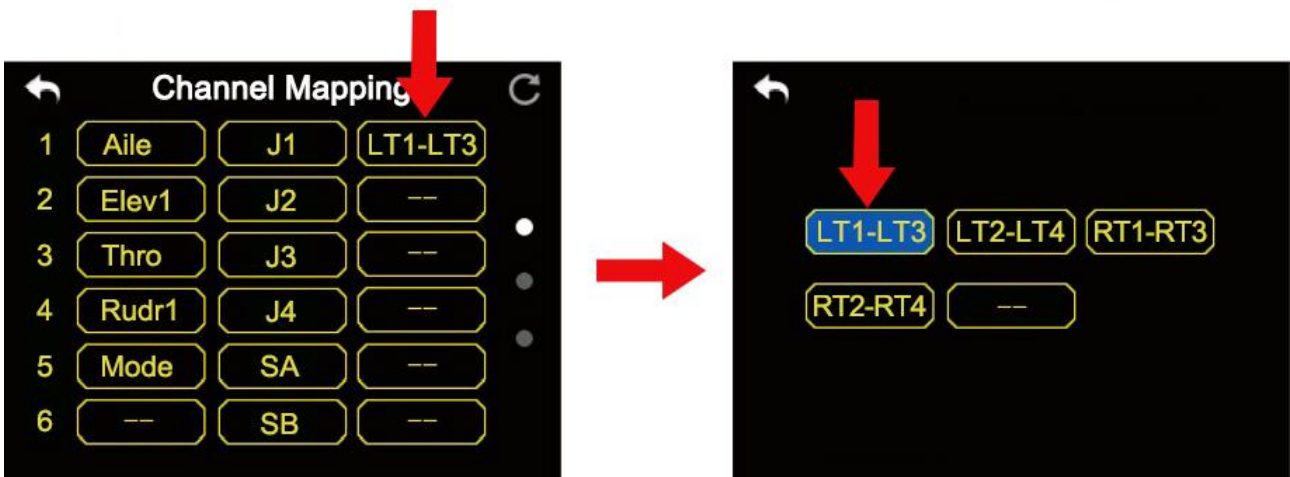

Mark

- In “Channel Mapping” page, if you are to redefine a channel, tap on the channel name, it comes a list of definition to all transmitter channels.

- Select one definition to finish.

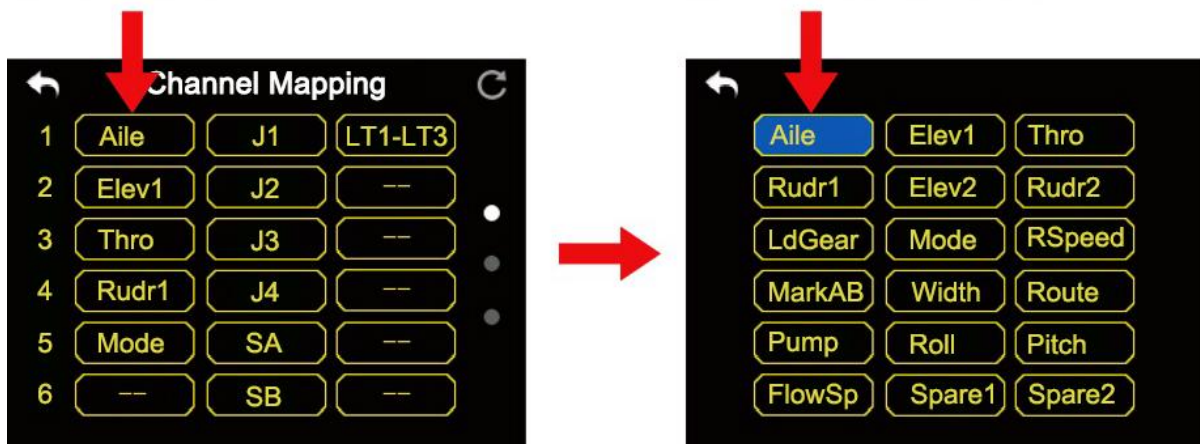

- And tap on “Reset” icon to rest all channel mapping settings.

DK32S Transmitter's Channel Definition Introduction

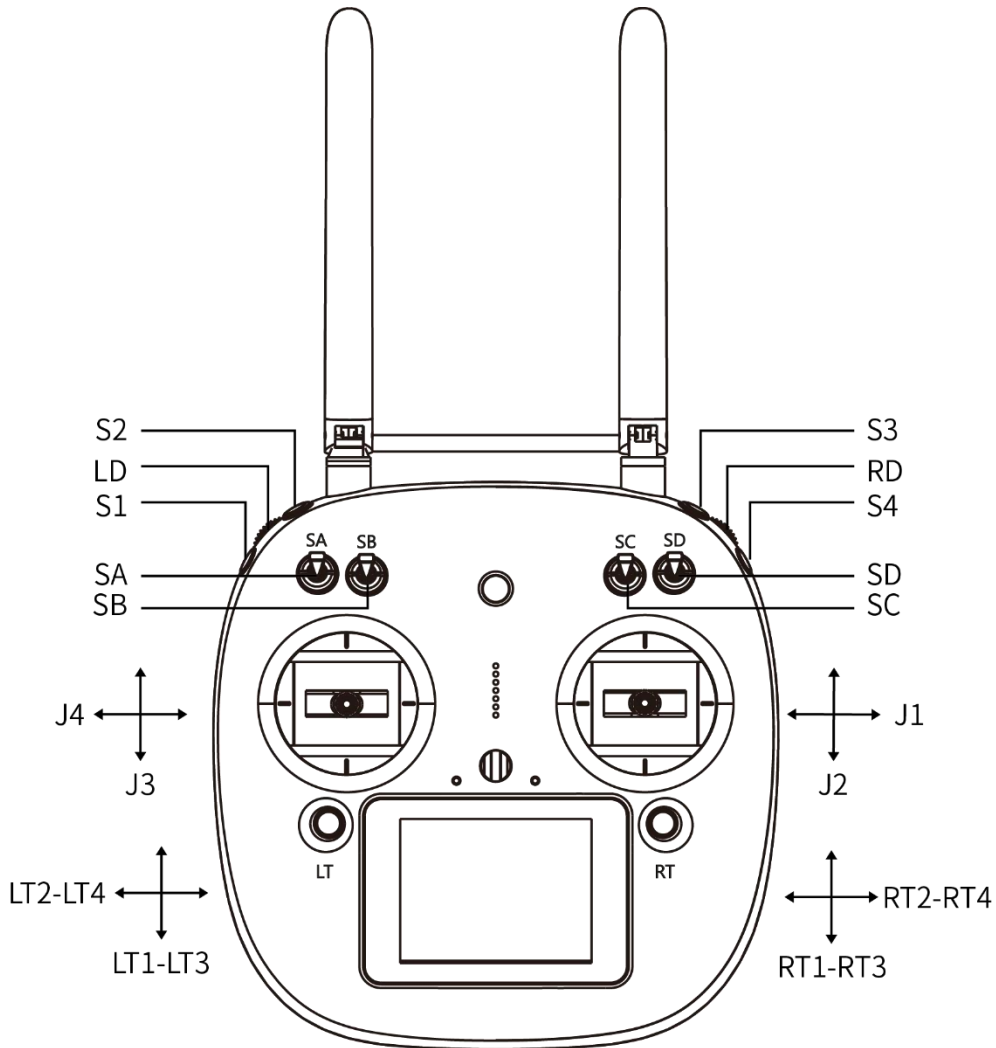

Sub-Trim Mapping

After channel mapping configuration, users can set Sub-Trim mapping accordingly through LT/RT switches.

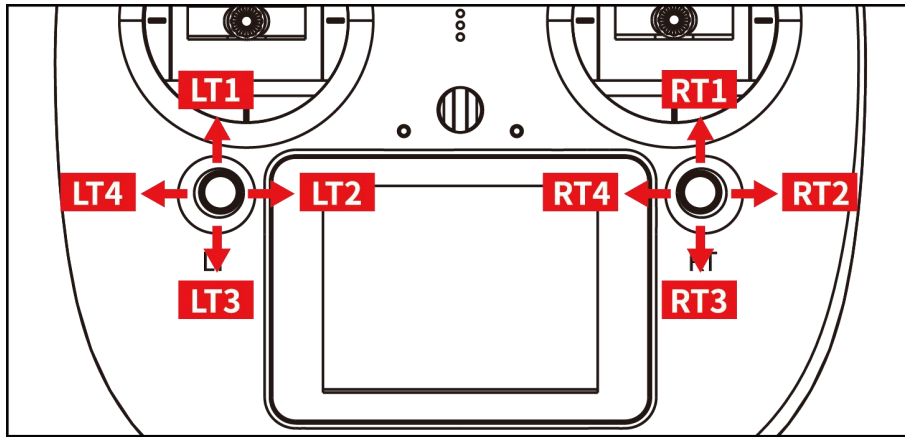

Mark: Sub-Trim mapping can be repeatedly used in different channels. Sub-Trim mapping will be reset along with resetting channel mapping. It is wise to backup.

5.6 Channel Reverse

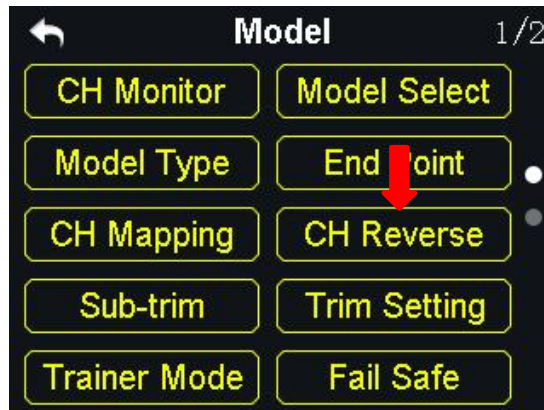



Users can reverse channel output in “Channel Reverse” page.

Steps

1. When your FT24 transmitter is bond to a new Air Unit, please check and if all servos, buttons, and switches are mapped to correct channels as you need.

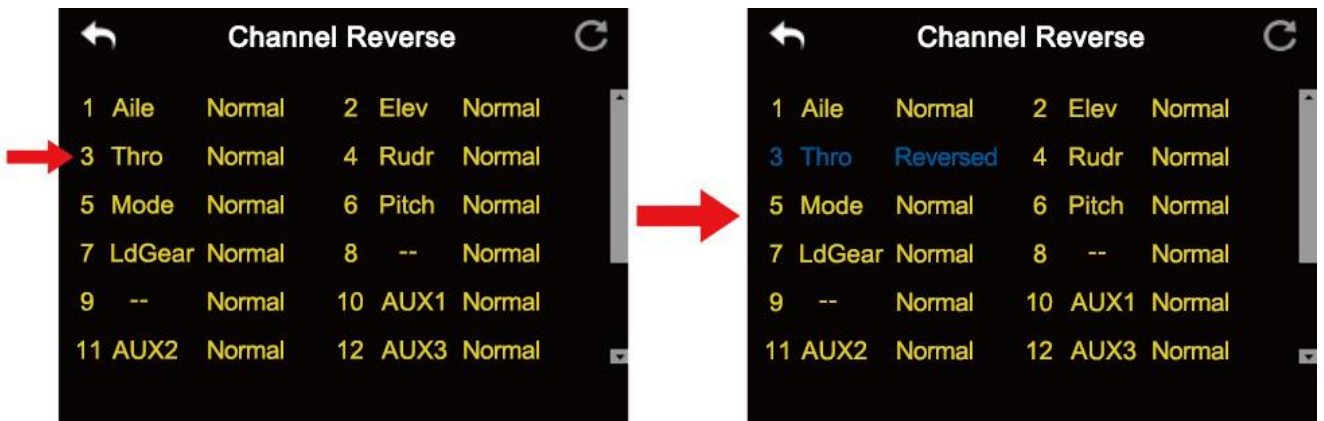
2. Please try to operate all joysticks, switches, and buttons on transmitter to check if channel output direction of each channel is normal or reversed.
3. Go to “Model” page, enter “Channel Reverse”.
4. The page displays information as in the picture below. Enter a channel once to select, twice to change it into “Normal” or “Reversed”.



 Mark: Enter “Reset” to reset all channels.

5.7 Sub-Trim



The sub-trim function helps users set the middle position value of a channel's and do trim adjustment to the aircraft's flight attitude.

Before doing sub-trim settings, please make sure that the target sub-trim channel is in its middle position.

 **CAUTION**

It is not a good idea to use sub-trim function when you are flying an agricultural drone.

Steps to Do Sub-Trim Settings

1. In the model settings menu, tap on “Sub-trim”, in the screen it shows the sub-trim menu;
2. Select a channel according to your requirement; use the virtual turntable to select a target middle channel value;
3. Repeat step 2 if you are to adjust any other channels.

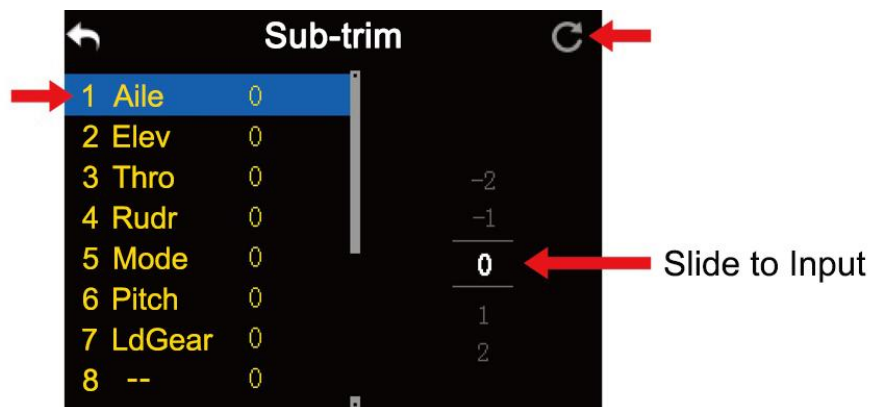

 **Mark:** In the sub-trim menu, tap on “Reset” to reset all channels.

5.8 Trim Settings

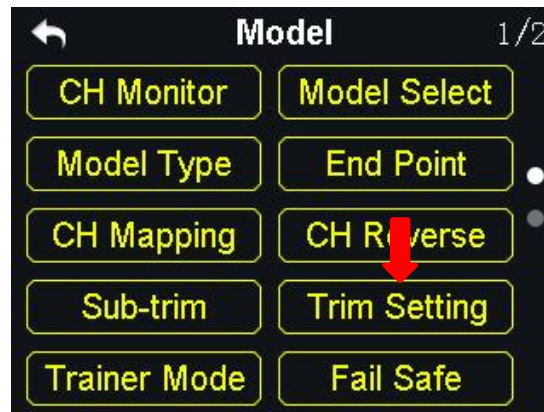

The trim setting function helps users adjust digital sub-trim’s stepping value.

The equivalence relationship between trim setting value and trim stepping value are,

$$5 \text{ Trim Setting Value} = 1 \text{ Trim Stepping Value}$$

That is, when the trim setting value is changed in 5, the trim stepping value changes in 1.

The DK32S transmitter’s trim setting value is default to be 5, the minimum limit of the trim setting value is 0, the maximum limit is 100; the minimum limit of the trim stepping value is 0, the maximum limit is 20.

Steps to Do Trim Settings

1. In the model settings menu, tap on “Trim Setting”, in the screen it shows trim settings menu;
2. Through the trim settings function, users are able to adjust all 4 sub-trim channels; tap on a channel according to your requirement to change its trim stepping value;
3. Use the virtual turntable to select a target trim stepping value, the adjustable range is from 0 to 100;

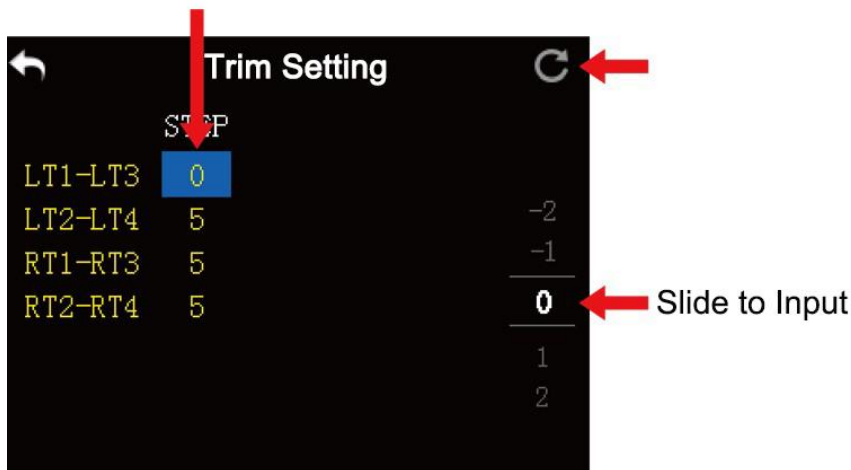

4. Tap on “Return” to finish.

Mark: In the trim settings menu, tap on “Reset” to reset all channels.

5.9 Trainer Mode

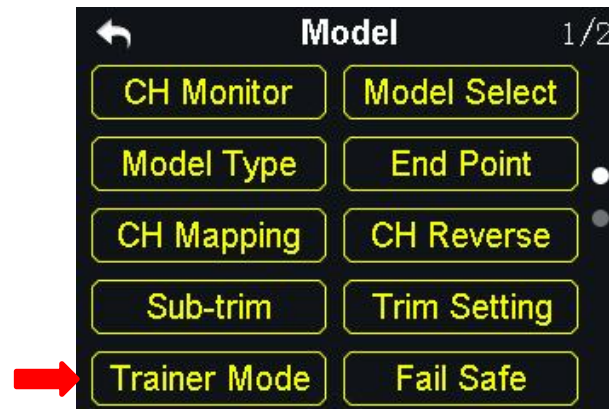

Trainer Mode (Master-Slave) helps experienced RC Hobbists train new talents. Under this mode, two DK32S transmitters can be linked through a trainer cable or be linked wirelessly. All channels are open for trainer mode, users decide which channel to use, and through a physical switch you can switch between master transmitter and slave transmitter.

About Trainer Mode

FUNC (Function)

OFF to turn off.

Wired to use trainer cable. Wireless to use wireless trainer.

MODE

Switch between master transmitter and slave transmitter.

CTL SW (Control Switch)

Define a physical switch to switch between master transmitter and slave transmitter.

JOY CTL (Joystick Control)

ON to take over control from slave transmitter on mater transmitter.

OFF to give back control to slave transmitter.

LINK

Bind master transmitter to slave transmitter.

5.9.1 Steps through Using Trainer Cable

1. Use trainer cable to connect the two DATA1 ports of master transmitter and slave transmitter.
2. Go to “Trainer Mode” page. It displays a list of all 16 channels.
3. Turn FUNC to “Wired” and assign “Master” transmitter and “Slave” transmitter.
4. When you are to define a physical switch for trainer mode control, tap on “NULL”, it displays “select a switch by operating it”. Then operate a switch, it goes to switch status page for defining its stages.

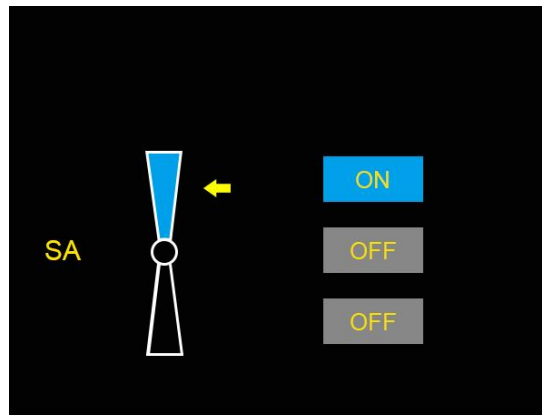
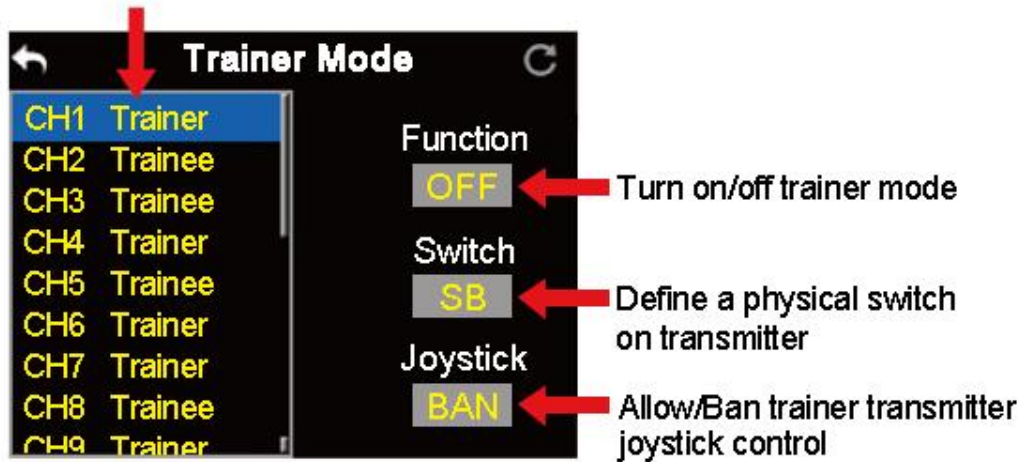

5. After defining, the switch takes over control of turning on / off trainer mode, so that master transmitter can take over control from slave transmitter in emergency.
6. If you turn on Joystick Control, master transmitter will take over control immediately by operating joysticks.

5.9.2 Steps of Wireless Trainer

1. Go to “Trainer Mode” page. It displays a list of all 16 channels.

2. Turn FUNC to “Wireless” and assign “Master” transmitter and “slave” transmitter.
3. When you are to define a physical switch for trainer mode control, tap on “NULL”, it displays “select a switch by operating it”. Then operate a switch, it goes to switch status page for defining its stages.
4. After defining, the switch takes over control of turning on / off trainer mode, so that master transmitter can take over control from slave transmitter in emergency.
5. If you turn on Joystick Control, master transmitter will take over control immediately by operating joysticks.
6. Start linking/binding master transmitter to slave transmitter by tapping on “LINK - Start”. Transmitter indicator turns to blink red fast. Then repeat the operation on slave transmitter, linking/binding is finished when transmitter indicator turns to green.
7. Wireless trainer setting is finished successfully.



Mark:

Slave Transmitter Indicator Green: Master and slave transmitter in communication.

Slave Transmitter Indicator Yellow: Master and slave transmitter off communication.

Master Transmitter Indicator Green: Master transmitter and Air Unit in communication.

Master Transmitter Indicator Yellow: Master transmitter and Air Unit off communication.

5.10 Fail Safe

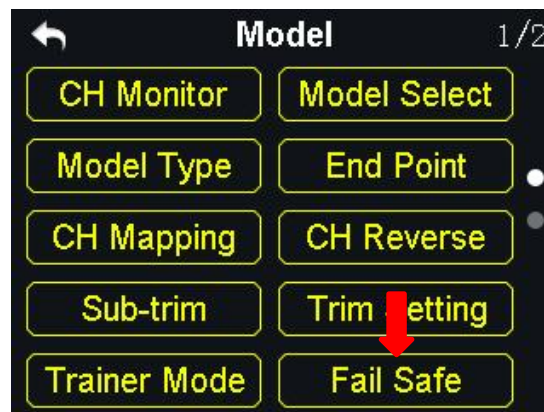

Before linking the DK32S transmitter to the sky station, do not forget to do fail-safe settings and turn on the function. Thus if the transmitter lost link with the sky station, the fail-safe function will run automatically and immediately to protect the aircraft from a crash.

Step to Do Fail Safe Settings

1. In the model settings menu, tap on “Fail Safe”, in the screen it shows the fail-safe menu;
2. In the fail-safe menu, the function is default to be off and it displays “HOLD” in every channel; in this circumstance, if the transmitter lost link with the sky

station, the channel values that the sky station outputs will be the ones received from the transmitter in the last moment;

3. Tap on “OFF” and switch it to “ON” to turn on the fail-safe function;
4. When the function is turned on, tap on a channel according to your requirement and switch “HOLD” to “0”, then use the virtual turntable to input channel value;
5. You can also input channel value by manipulating a joystick, a switch, a button, or a dial which is mapped with the channel; input a target value, tap on “SET” to finish;
6. The virtual turntable helps users to adjust channel value more accurately when it is very close to the target value.

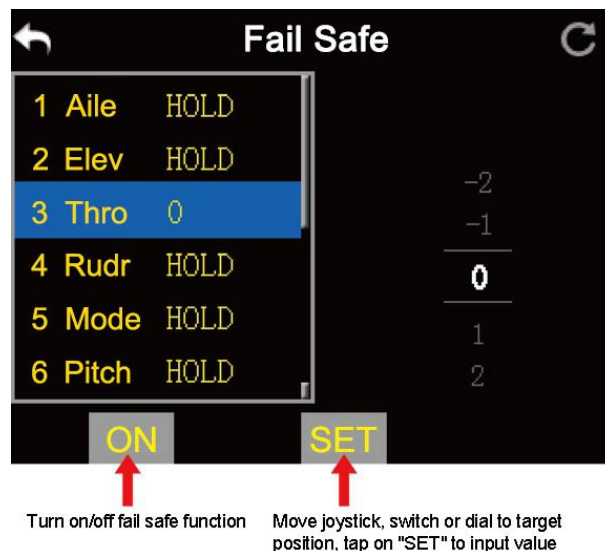

! WARNING

For flight safety, the fail-safe settings must be done and the function must be turned on.

5.11 Timer

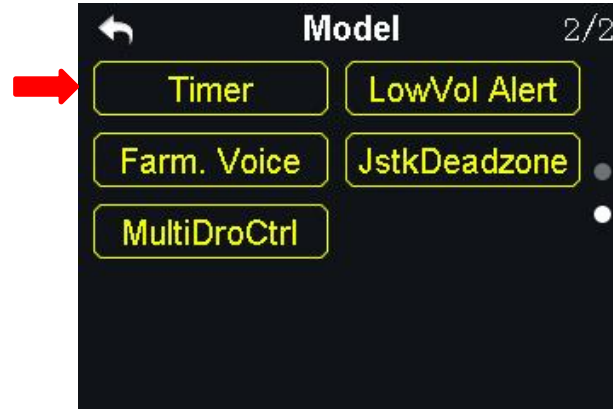

In the DK32S transmitter main menu there are two timers.

Timing Mode

Up: Counts from 0, the timer alerts when it reaches the time.

Down: Counts from the start time, the timer alerts when it is back to 0.

Define a Timer Function Switch

Start: Define a switch / button for "Start".

Stop: Define a switch / button for "Stop".

Reset: Define a switch / button for "Reset".



5.12 Voltage Alert

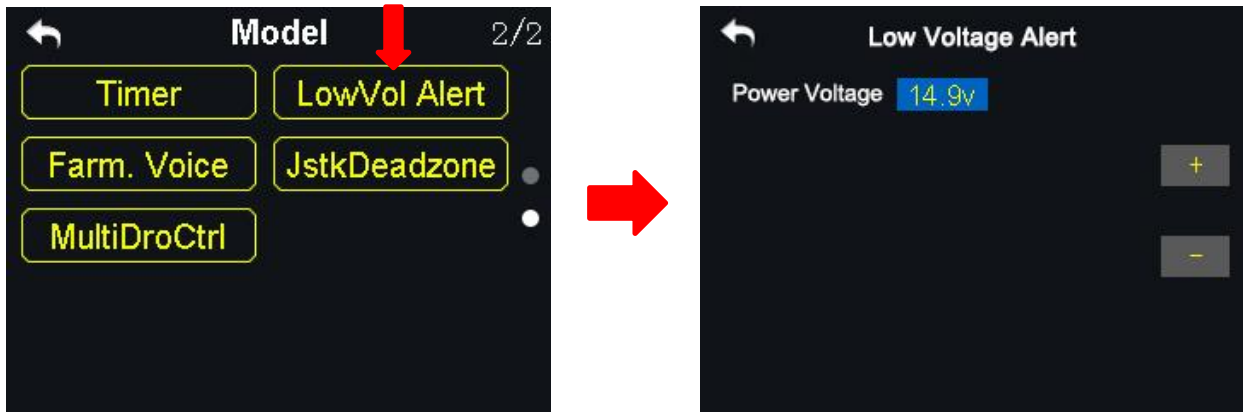

When the user's aircraft power voltage is lower than the safe level, the DK32S transmitter will vibrate and send voice alert.

Steps

1. In the model settings menu, tap on "Voltage Alert", in the screen it shows the voltage alert menu;
2. Tap on power voltage, then "+/-" to input the target voltage value according to your requirement;
3. Tap on "Return" to finish.

5.13 Farming Voice



The Farming Voice is a professional function is for farming drones. The function is supported by up to 6 switches with 16 positions. They are SA, SB, SC, SD, S2 and S3.

Steps

1. In the model settings menu, tap on “Farming Voice”, in the screen menu it shows the farming voice menu;



2. In the farming voice menu, tap on “ON/OFF” to enable/disable the function;
3. Select a switch and a position; in the screen menu it shows the voice list; select a voice to define the switch;
4. Repeat step 3 if you are to define the other switches.

Voice List



Atti. (Attitude): Attitude Mode

Stab. (Stablize): Stable Mode

Hold (AttiHold): Attitude Hold Mode

GPS: GPS Mode

AB Ln (AB Line): A/B Line Flight Mode

Auto (AutoMode): Auto Flight Mode

Rcd A (Record A): Record A Point

Rcd B (Record B): Record B Point

ExeAB (Execu AB): Execute A/B Line (for Topxgun flight controller only)

Clear (Clear AB): Clear AB Line

SpON (SprayON): Turn on spraying.

SpOFF (SprayOFF): Turn off spraying.

RTH (RtnHome): Drone return to home

RTB (RtnBreak): Drone return to breakpoint

Loit. (Loiter): Loiter Mode

RaON (RadarON): Turn on radar

RaOFF (RadarOFF): Turn off radar

AuSpr (AutoSpr): Auto Spraying

MnSpr (ManulSpr): Manual Spraying

LtON (LightON): Navigation light on

LtOFF (LightOFF): Navigation light off

5.14 Joystick Dead Zone

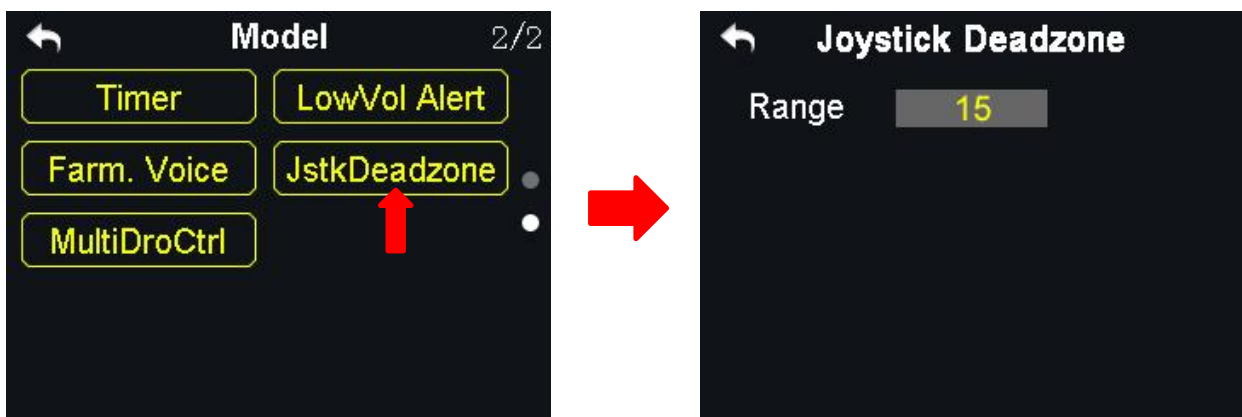

By setting a certain dead zone range, the DK32S transmitter helps user filter out channel values which are input by touching the joysticks unintentionally.

When the range is set, the channel value does not change if the joysticks stay moving in the range; when the joysticks move out of the range, the channel value continues to change.

Steps to Set Dead Zone

1. In the model settings menu, tap on “JstkDeadZone”, in the screen it shows the Joystick Dead Zone menu;
2. Tap on the range, then “+/-” to input a target range according to your

requirement;

3. Tap on “Return” to finish.

5.15 Multi-Drone Control

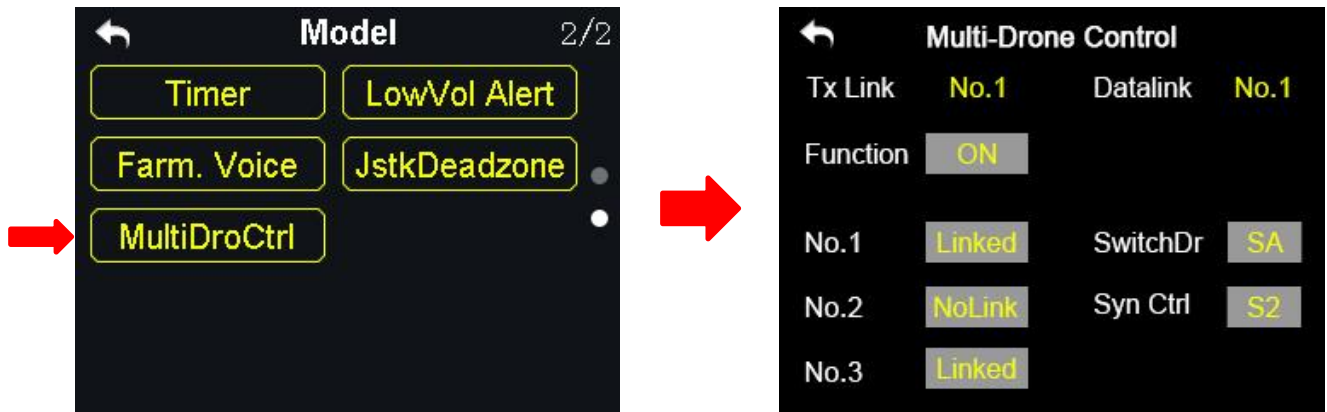

Through one DK32S transmitter users can control up to three drones at the same time.

Switch Drone

The function is to switch the control of linked drones, from drone No.1 to No.3.

When the “Syn-control” function is not activated, the DK32S transmitter controls one drone only. At this time, if you switch the control of a linked drone to another, for the uncontrolled drones, the channel value of CH1-4 stays in center (1500), the other channels stays not changing. The datalink goes with the drone in control.

Syn-Control

When the “Syn-control” function is activated, the DK32S transmitter can control up to three drones at the same time. In this circumstances, all drones fly at the same

pace. The datalink only goes with one drone, which is the drone in control before activating the “Syn-control” function.



CAUTION

Please keep a safe distance between the drones when the “Syn-Control” function is activated.

Steps

1. In the model settings menu, tap on “MultiDroCtrl”, in the screen it shows the multi-drone control menu;
2. Tap on “SwitchDr”, define a 3-stage switch according to your requirement to switch the control of the drones;
3. Tap on “Syn-Control”, define a 2-stage switch or a button (S3/S4 is better) to switch on/off the function;
4. Hold the “link” button on the sky station of the drone No.1; when the indicator blinks red fast, go to the “MultiDroCtrl” menu, tap on “NoLink” of the drone No.1; When the indicator is on green, linking is finished.
5. Repeat Step 4 for drone No.2 and drone No.3 to finish all the linking process.

6 SYSTEM SETTINGS

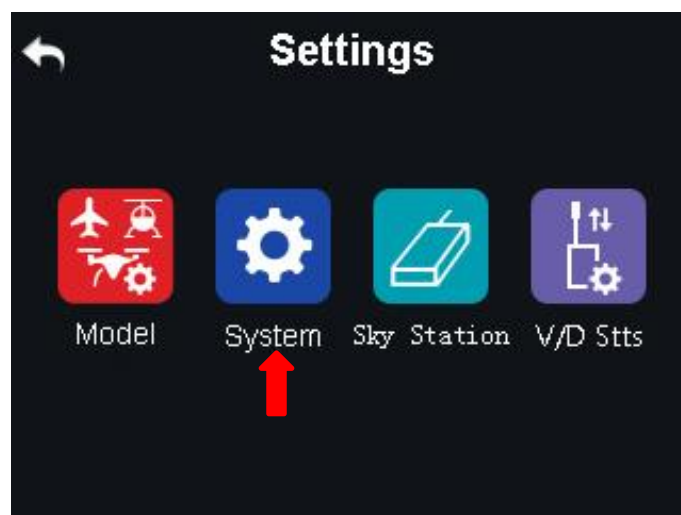

Functions

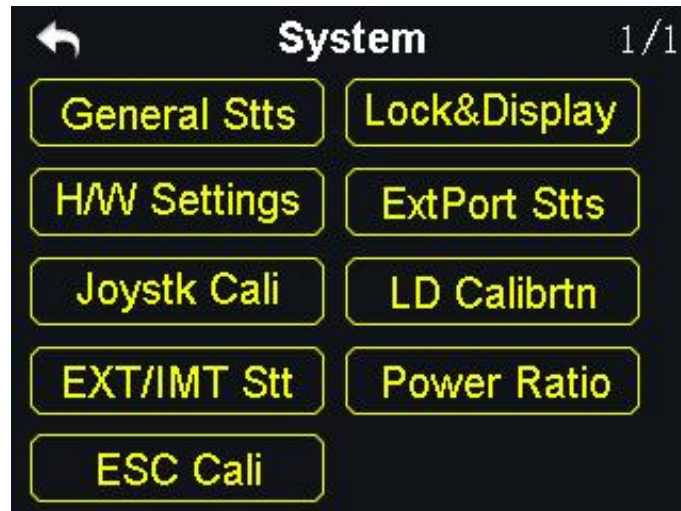

General Stts (General Settings): Set transmitter's basic functions

Lock&Display (Screen Lock & Display): Turn on / off the display of the transmitter touch screen and adjust brightness

H/W Settings (Hardware Settings): Change the hardware definition of several transmitter channels through software settings

ExtPort Stts (Extending Ports Settings): Set the definition of the transmitter's extending ports

Joystk Cali (Joystick Calibrating): Calibrate the joysticks

LD Calibrtn (LD Calibrating): Calibrate the left dial (LD)

EXT/IMT Stt (Export/Import Setting Data): Export the transmitter settings or model settings

Power Ratio: Adjust the power ratio

ESC Cali: Calibrate ESC through PWM ports on the sky station

6.1 General Settings

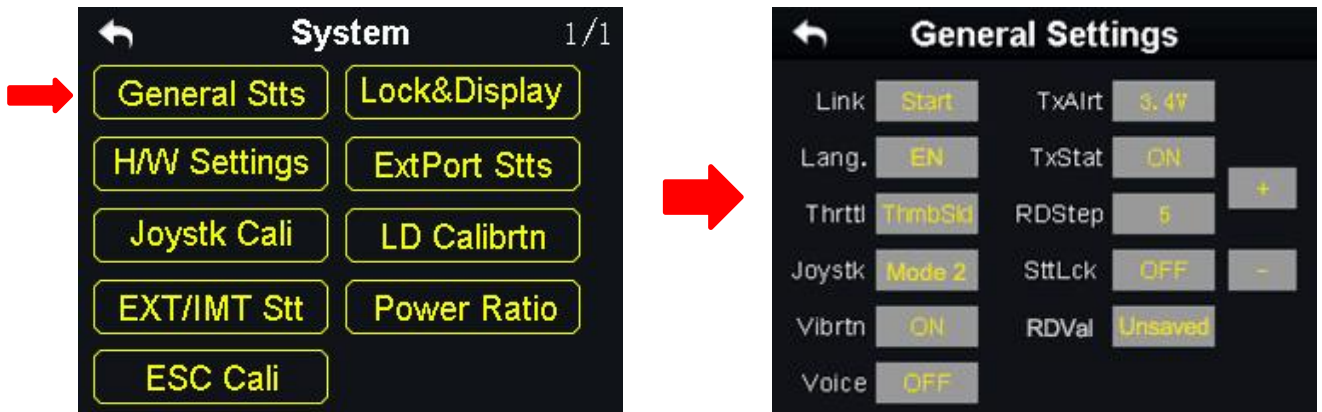

General Settings Menu Introduction

Link (Linking): Start linking the DK32S transmitter to the sky station.

Lang. (Language): Switch the system language between Chinese/English.

Thrttl (Throttle Type): Switch the throttle joystick type between “Self-centering” and “Thumb-slide”.

Joystk (Joystick Mode): Switch the joystick mode from American Hand / Japanese Hand / Chinese Hand / Custom Hand.

Vibrtn (Vibration): Turn on / off the vibration alert function.

Voice (Voice Broadcast): Turn on / off the voice broadcast function.

TxAirt (Transmitter Low Battery Level Alert): Set a limit for the transmitter battery level lower than which transmitter will alert.

TxStat (Transmitting Status): Turn on / off the radio signal transmitting.

RDStep (RD Stepping Value): Set the stepping value (range: 1-100) of the right dial (RD). Higher it is, more channel value the channel value increases in a single movement.

SttLck (Setting Lock): When the setting lock is “ON”, password is required for entering the transmitter setting menu (the default password is “8888”); when the setting lock is “OFF”, no password is required.

RDVal (RD Value): When it is “Unsaved”, the RD channel returns to the default channel value (1500) the next time you power on the transmitter; when it is “Saved”, the RD channel stays at the channel value before the last powering off.

6.2 Screen Lock & Display

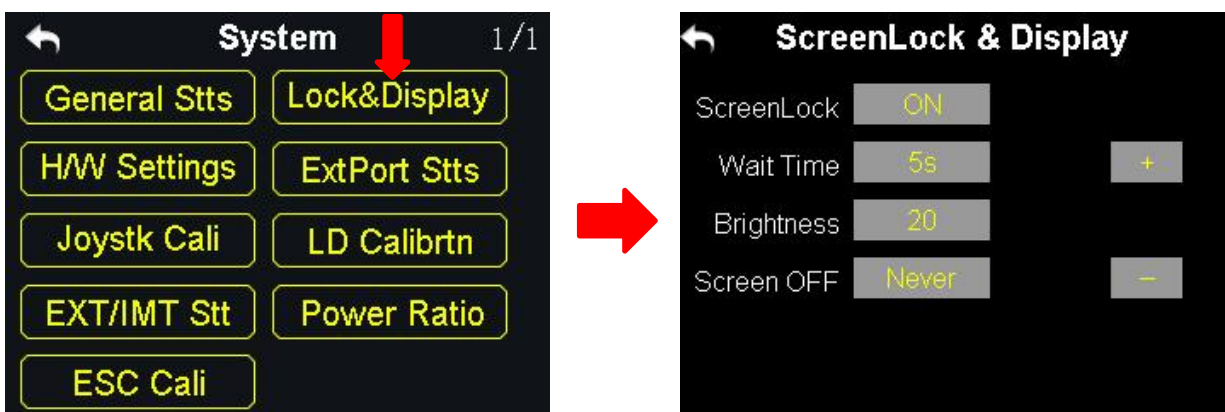

Users can turn on / off the screen lock, set the waiting time, adjust the screen brightness and the screen sleep waiting time of the DK32S transmitter.

Screen Lock and Display Introduction

Screen Lock: The touchscreen lock is disabled when the screen lock is enabled.

Screen Lock Waiting Time: Set the waiting time before locking transmitter screen.

Screen Brightness: Adjust the screen brightness (range 1 - 20).

Screen Sleeping Time: Turn on / off the sleeping function (screen display turns off automatically after waiting time) of the transmitter screen and set waiting time. When you set “Never”, the transmitter screen stays on.

Mark: When the screen lock is enabled, press down a sub-trim button (LT5 direction of left sub-trim button, RT5 direction of right sub-trim button) for 3 seconds to unlock the screen.

6.3 H / W Settings

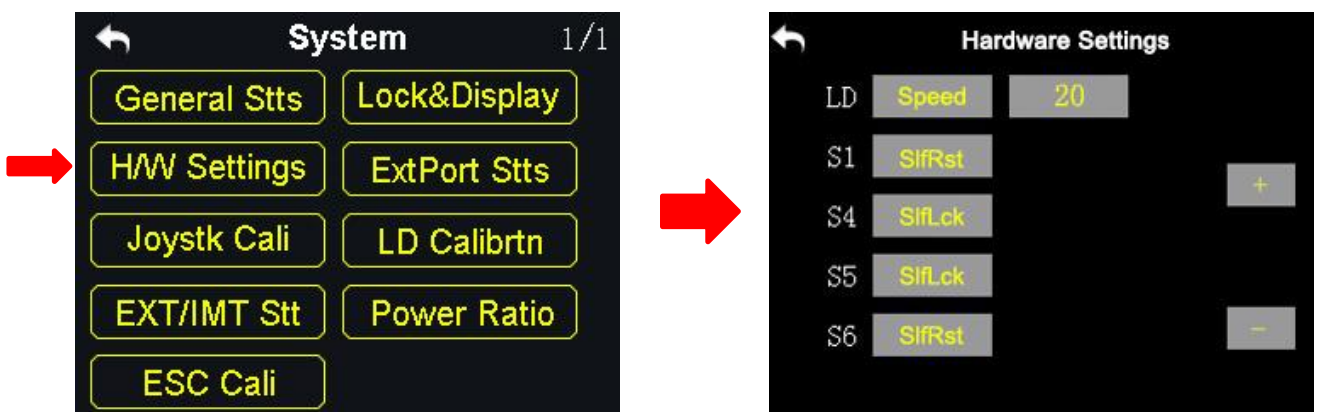

Through the H / W settings users can do advanced settings for the left dial (LD) to switch it between the Position Mode and the Speed Mode and the switch S1 / S4 / S5 / S6 to switch between Self-locking and Self-resetting.

The Difference between the Left Dial (LD)'s Position and Speed Mode

Position Mode: Output of the LD channel value depends on the dial's position. More dial angle it changes, more channel value it outputs.

Speed Mode: Output of the LD channel value depends on the dial's rotating speed. Faster the dial rotates, more channel value it outputs. The speed mode is widely used among aerial photography users to change the camera angle.

Steps

1. In the system settings menu, tap on "H / W Settings", in the screen it shows the H / W settings menu;
2. Tap on "Position / Speed" to switch the left dial's working mode; in speed mode, "+ / -" is to input the stepping value so as to change the LD's rotating speed.

How to Define the S1 / S4 / S5 / S6 Switch

In the H / W settings menu, select a switch according to your requirement, tap on "Self-locking / Self-resetting" to define the working mode.

6.4 Extending Ports Settings

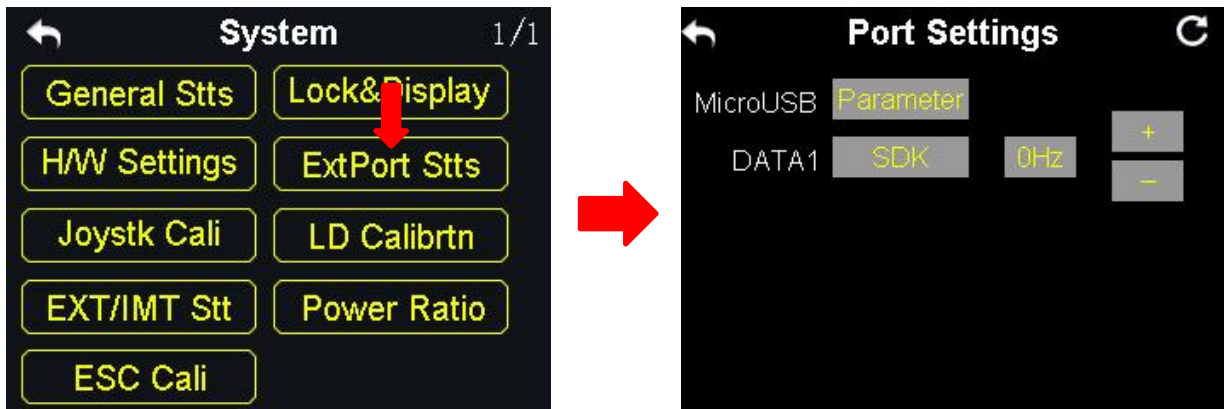

The extending ports function help users extend transmitter function to external hardware devices and SDK. Currently the DK32S transmitter supports a Micro-USB port, a USB port and a 4-Pin Groove Port (DATA1).

The Assigned Function to the Extending Ports

Micro-USB: Charging, parameter adjustment, firmware upgrading and datalink output.

USB: Datalink output.

DATA1: Firmware upgrading of the sky station, trainer mode and SDK.

Steps to

1. In the system settings menu, tap on “Extending Ports Settings”, in the screen it shows the extending ports settings menu;
2. Select DATA1 to assign a function (transmitter / sky station / GPS / SDK);
3. Under “Transmitter”, the DATA1 port supports the trainer mode, output of the trainer transmitter and input of the student transmitter;
4. Under “sky station”, the DATA1 port supports upgrading the sky station

- firmware (please refer to the DK32S Sky Station User Manual for more);
5. Under “GPS” mode, the DATA1 port supports the GPS module. Agricultural drone pilots use the GPS module with the DK32S transmitter to mark flight points;
 6. Under “SDK”, the DATA1 port supports output of the joystick channel value. Tap on “+ / -” to increase or decrease output frequency.

SDK Agreement Format

Field	Index	Bytes	Description
STX	0	1	0X55
Data Length	2	1	Data field byte length value: 32
CMD ID	5	1	0x00
DATA	6	32	Joystick channel data Data type: 16-byte unsigned int for channel 1-16
Check Sum	38	1	8 bytes (check sum from 0 byte to 37 byte)

6.5 Joystick Calibrating

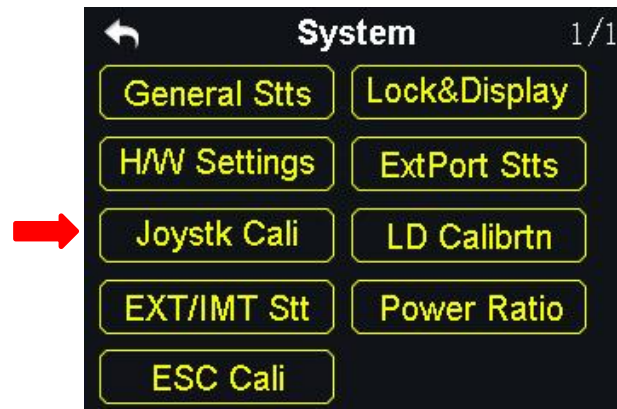

The Joystick calibrating function help users calibrate the joysticks' middle position.

Regular calibration can maintain the control accuracy of the joysticks.

No calibration is required if it was the thumb-slide joysticks. The self-centering joysticks require calibrating when they fail to reach the maximum / minimum positions or when they stay out of the middle position (channel value is not 0).

Steps

1. In the system settings menu, tap on "Joystick Calibrating", in the screen it shows the calibrating menu of the joystick;
2. The cross coordinate system displays the real-time position of the joysticks;
3. Tap on "Start", in the screen it pops up "Confirm if both the joysticks are in the middle position";

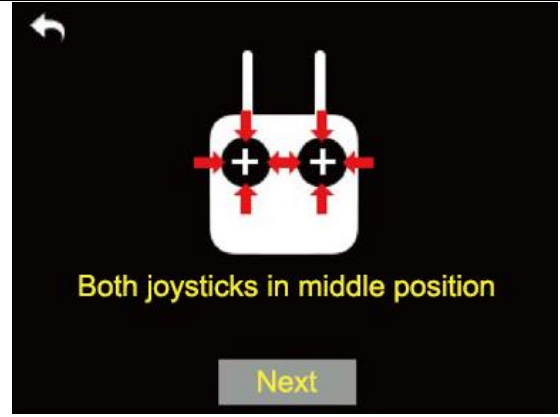
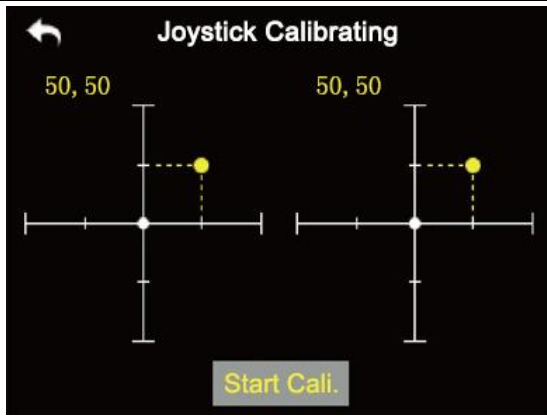

4. Hold the joysticks and make them stay in the middle position (the joystick's tick mark aligns with the transmitter's tick mark), then tap on "Next";
5. The transmitter starts detecting the middle position automatically, do not touch the joysticks while you are waiting;



6. When the detecting is finished, push both joysticks to the maximum position and move them in circle for several times;
7. Tap on "Finish" when it is over.

6.6 LD Calibrating

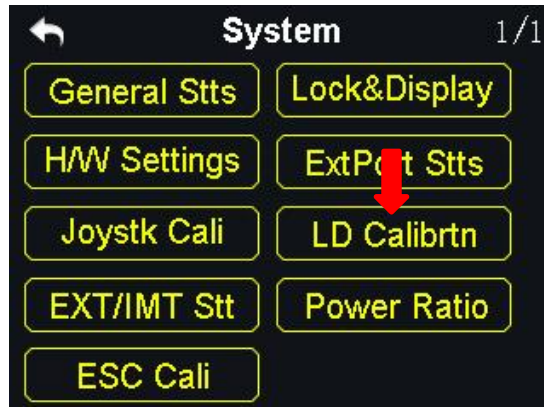

Calibrating the left dial can maintain its output accuracy. The left dial requires calibration when it stays out of the middle position (channel value is not 0) or it fails to reach the maximum / minimum position.

Steps to Calibrate LD

1. In the system settings menu, tap on “LD Calibrating”, in the screen it shows the LD calibrating menu;

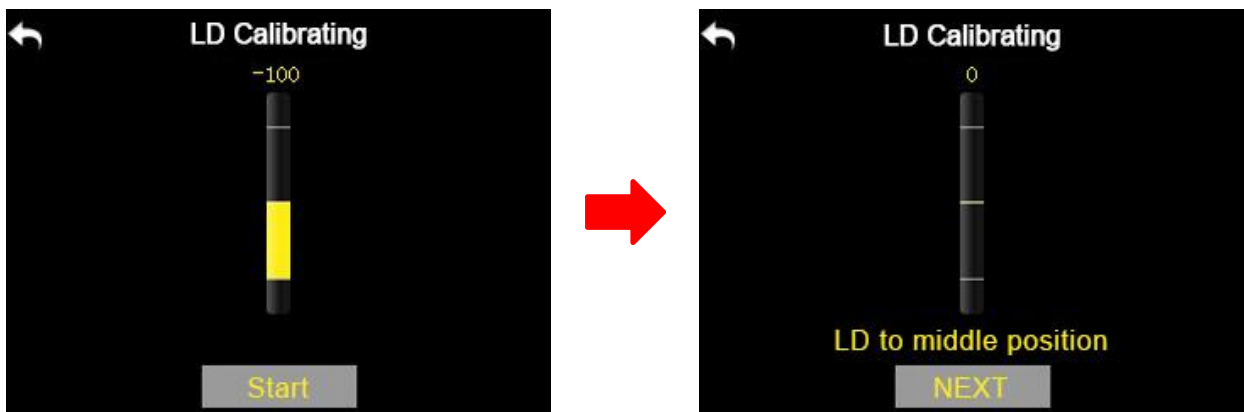

2. Tap on “Start”, in the screen menu it shows “LD to the middle position”;
3. Make sure the left dial is in the middle position, then tap on “Next”; in the screen it shows “Calibrating LD’s middle position, do not move LD”;
4. Please do not touch the left dial until it shows “LD to the maximum and minimum position”; follow the hint and repeat it several times;

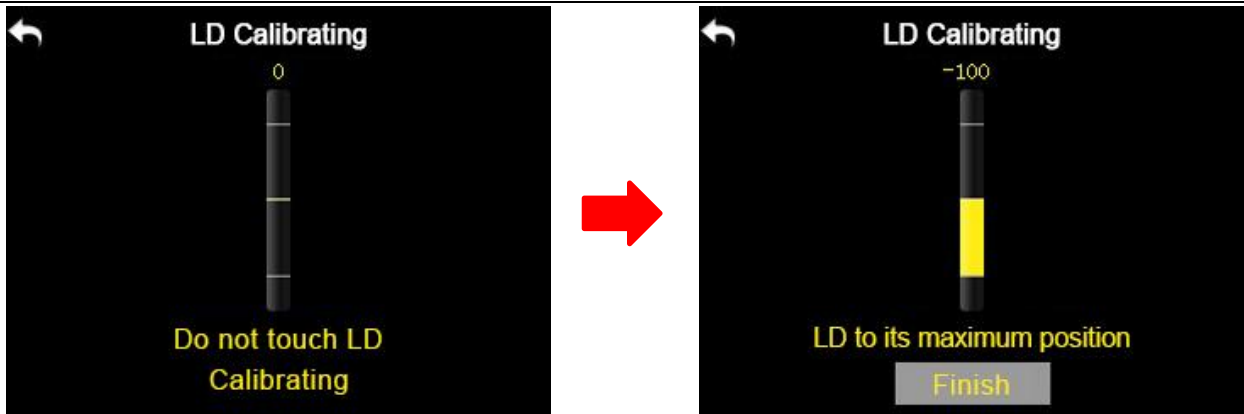

5. Tap on “Finish” when it is over.

6.7 Export/Import Setting Data

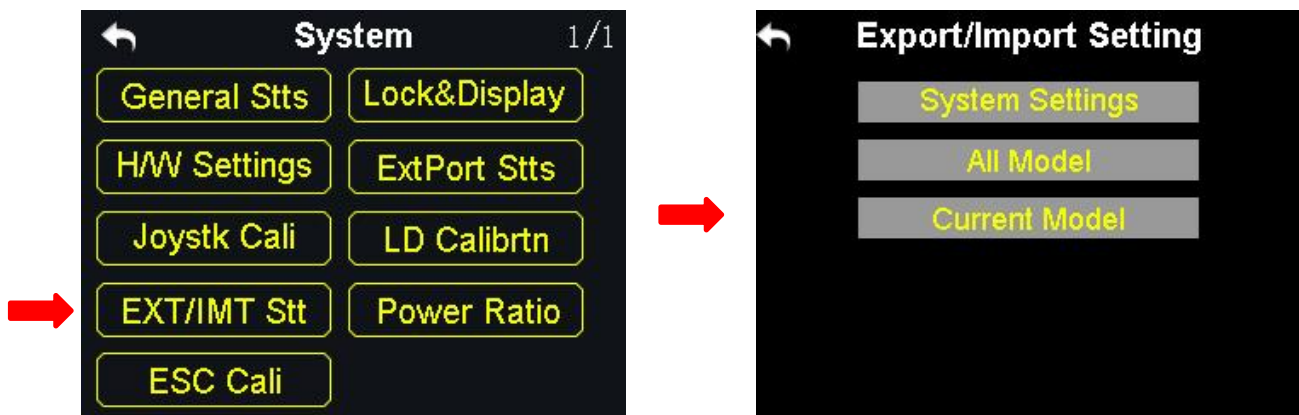

Through the export setting function users can export the data of system settings and model settings to the SD card so as to share the data to another DK32S transmitter.

Steps to Export Setting Data

1. Insert the SD card to the DK32S transmitter (ignore this step if it was there);
2. In the system settings menu, tap on “EXT/IMT Stt”, in the screen it shows the export/import setting data menu;

3. Tap on “System Settings” to export the transmitter’s system setting data, “All Models” to export all the data of model settings saved in the transmitter; if you are to export the data of the current model’s settings, tap on “Current Model”;
4. In the screen it pops up “Confirm to export” dialog, tap on “Confirm” to finish.

Steps to Import Setting Data

1. Connect the DK32S transmitter to the computer via USB cable, and open the “SIYI Assistant” software;
2. Import the setting data saved in the SD card to the computer through a SD card reader, the files are in format “.CFG”. The data of the system settings is named as “SYS.CFG”, the data of all model settings is named as “ALL.CFG”; the data of the current model settings is named as “MODEL+X(model number).CFG”;
3. In the “SIYI Assistant” software, tap on “Upgrade”; in “Setting Files”, tap on “Select File” to load setting files;

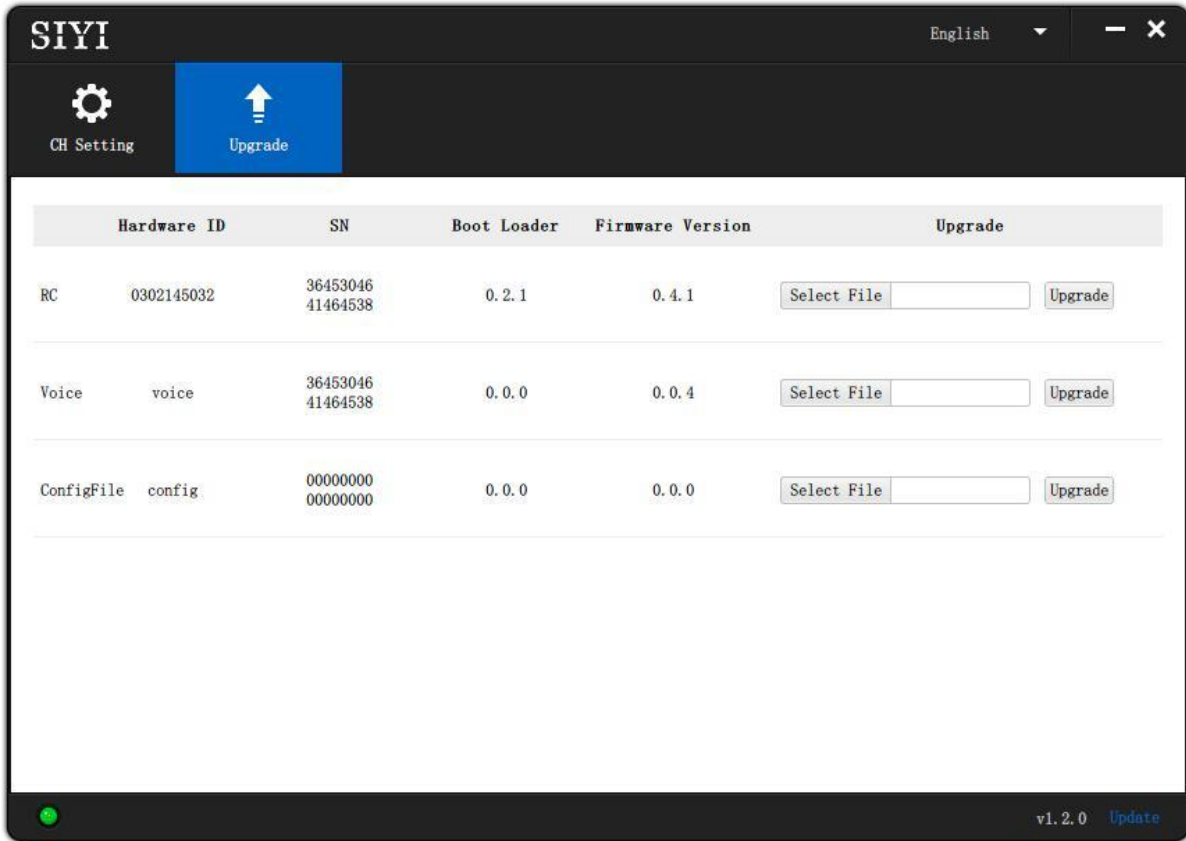

4. Tap on “Upgrade” to finish.

6.8 Power Ratio

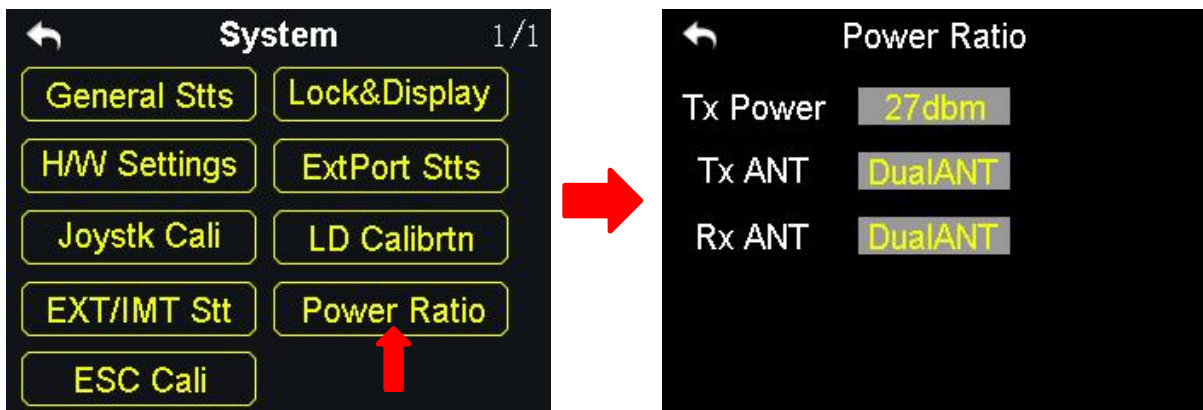

6.8.1 RF Power

Power ratio function helps users adjust RF transmitting power output according to their requirement. Optional output power are 10dBm and 27 dBm.

Steps

1. Power on the transmitter and sky station, make sure that they are linked with each other;
2. In the system settings menu, tap on “Power Ratio”, in the screen it shows the power ratio menu;
3. Tap on “RF Power” to choose “10dBm” or “27dBm” for power output;
4. Tap on “Return” to finish setting.

6.8.2 Transmitter/Sky Station Antenna



Both the transmitter and the sky station have two antennas. Users can decide which antenna to use, the antenna 1, the antenna 2 or both according to their requirement.

Steps to Choose the Antenna(s)

1. Power on the transmitter and the sky station, make sure that they are linked with each other;
2. In the system settings menu, tap on “Power Ratio”, in the screen it shows the power ratio menu;
3. Tap on “Tx/Rx ANT” to choose “ANT1/2” or “DualATN” for transmitter/sky station antenna;
4. Tap on “Return” to finish.

CAUTION

Please make sure that the distance between your transmitter and sky station is within 2 meters long.

6.9 ESC Cali

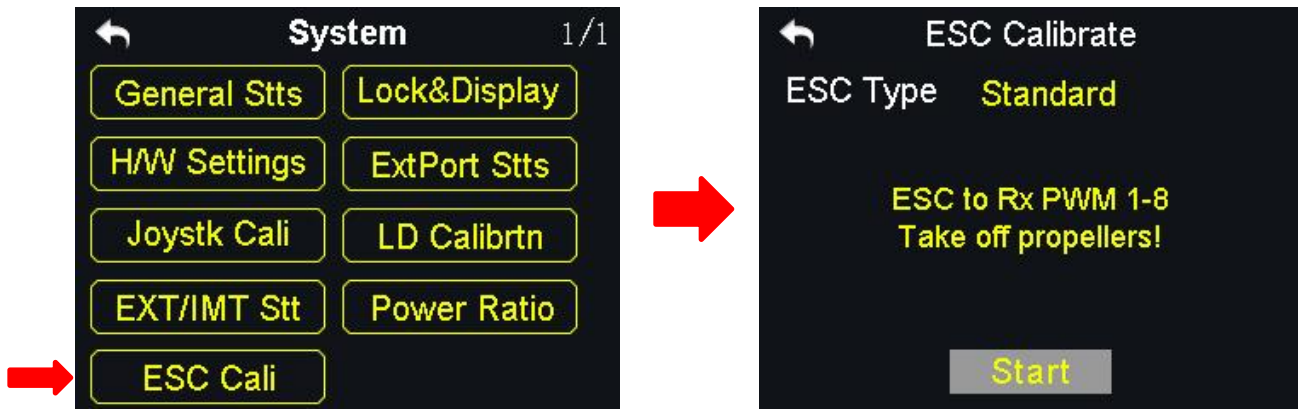

The DK32S transmitter simplified the ESC calibration a lot. Users just connect their ESC to the DK32S sky station's PWM port 1 to 8, then follow the tips in the screen menu or the steps below to finish calibration.

Steps to Calibrate the ESC

1. In the system settings menu, tap on "ESC Cali", in the screen it shows the ESC calibration menu;
2. According to the tips in the screen, connect your ESC signal wires to the sky station's PWM port 1-8, then tap on "Start";
3. In this circumstances, the channel value of transmitter throttle stick reaches to the maximum position automatically (do not push any joysticks); Supply power to the aircraft, and wait for the confirming sound from aircraft motors; Then tap on "Next", the channel value of the transmitter throttle stick reaches to the minimum position automatically, and wait for the confirming sound again;
4. The ESC calibrating is finished, you can cut off the power supply.

7 Sky Station Settings

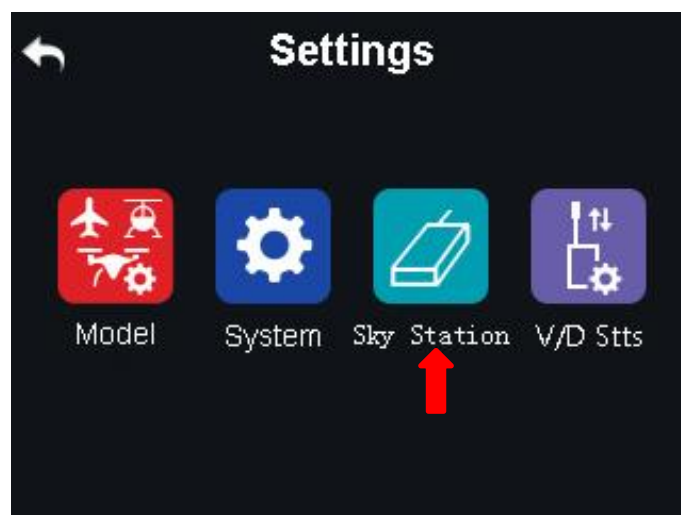

Functions

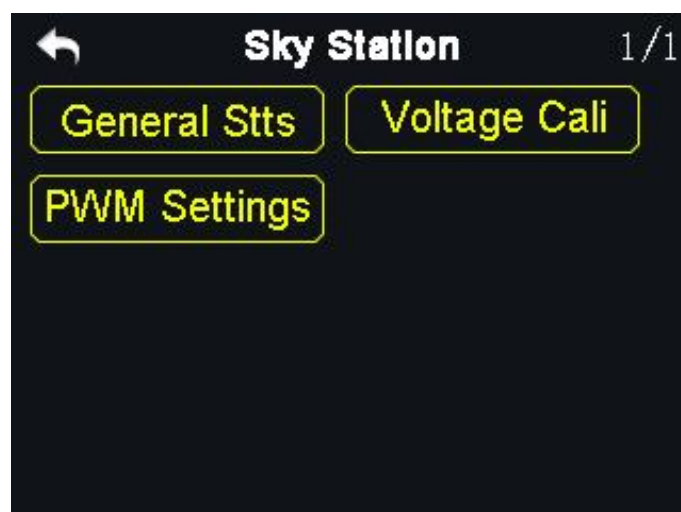

General Stts (General Settings): Set the basic functions of the sky station.

Voltage Cali (Voltage Calibrating): Calibrate the voltage telemetry.

PWM Settings: Change the channel definition under the PWM mode.

7.1 General Settings

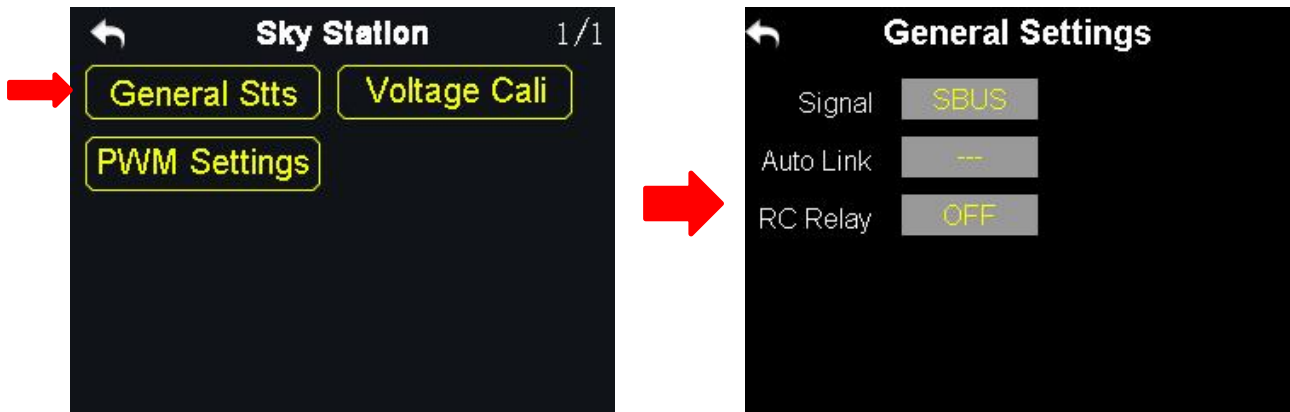

7.1.1 Signal Mode

Set signal mode for the three different output mode of the sky station, SBUS, PPM and PWM.

Steps

1. In the general settings menu, select “Signal Mode” and tap on “SBUS / PPM / PWM” to switch different signal modes;
2. The sky station status indicator blinks yellow once when it is switched to the SBUS mode, yellow twice to the PPM mode, yellow 3 times to the PWM mode;
3. When it is done, the status indicator of the sky station blinks green in all modes, and the blinking speed indicates the signal strength. Faster it blinks, weaker the signal strength is.

7.1.2 Automatic Linking

When the sky station is powered on, turn on the automatic linking function. If it receives no signal from the transmitter in 20 seconds, the sky station starts linking to the transmitter automatically.

The automatic linking function is to simplify procedure. It is necessary to turn on the function before installing the sky station into the aircraft body, in case that they may have no approach to the linking button of the sky station.

CAUTION

Do not turn on the automatic linking function when you are using more than one sky stations at the same time.

7.1.3 Voltage Telemetry

When the voltage telemetry function is turned on, in the PWR (power) column of the DK32S transmitter main menu, users can check the real-time display of the aircraft voltage telemetry.

7.1.4 Remote Control Relay

The function helps users with long distance flight relay. It supports two transmitters at most.

How to Use the Remote Control Relay Function

1. Prepare two DK32S transmitters, mark them with 1 and 2;
2. Please link the transmitter 1 to the sky station first, then turn on “Remote Control Relay” in the “General Settings Relay” menu; the transmitter 1 is the slave transmitter;
3. Then link the transmitter 2 to the sky station; the transmitter is always the master transmitter even if you restart the sky station or transmitter.

7.2 Voltage Calibrating

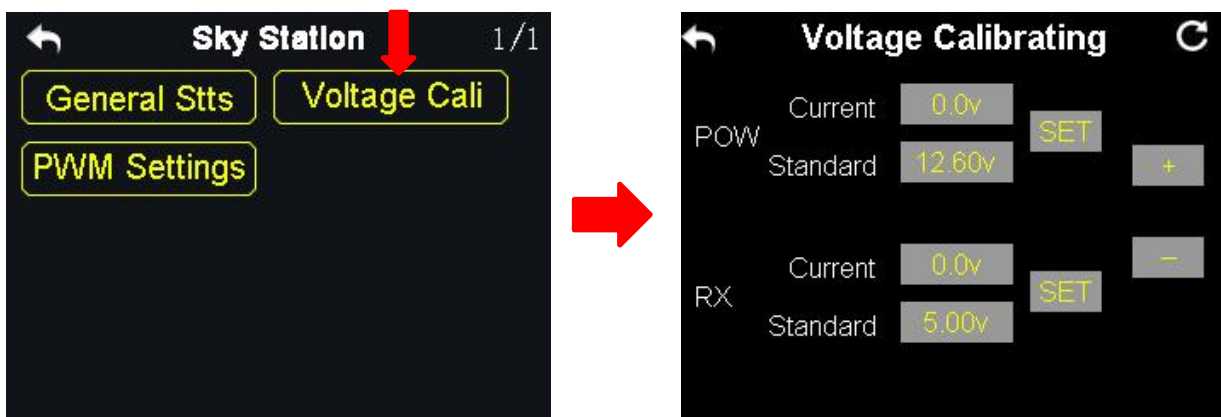

Before using the sky station, it is necessary to calibrate the telemetry voltage of both the sky station and the aircraft.

Here are some preparing work before calibration:

1. Power on the sky station and the transmitter;
2. Link the sky station to the transmitter.

Steps to Calibrate the Telemetry Voltage of the Sky Station (RX)

1. Power on the sky station through any of the PWM port, the voltage range is from 3.6V to 10V, measuring by a multi-meter;
2. Let's take an example of 6.0V; select “Standard Voltage” in the RX menu, tap

on “+/-” to set the standard voltage to 6.0V;

3. Tap on “SET”, in the screen it pops up “Calibrating Succeed”, the calibration is finished.

Steps to Calibrate the Telemetry Voltage of the Aircraft Power (POW)

1. Power on the sky station through the POW port, the voltage range is from 3.3V to 50V, measuring with a multi-meter;
2. Let’s take an example of 25V; select “Standard Voltage” in the POW menu, tap on “+/-” to set standard voltage to 25V;
3. Tap on “SET”, in the screen it pops up “Calibrating Succeed”, the calibration is finished.

7.3 PWM Settings

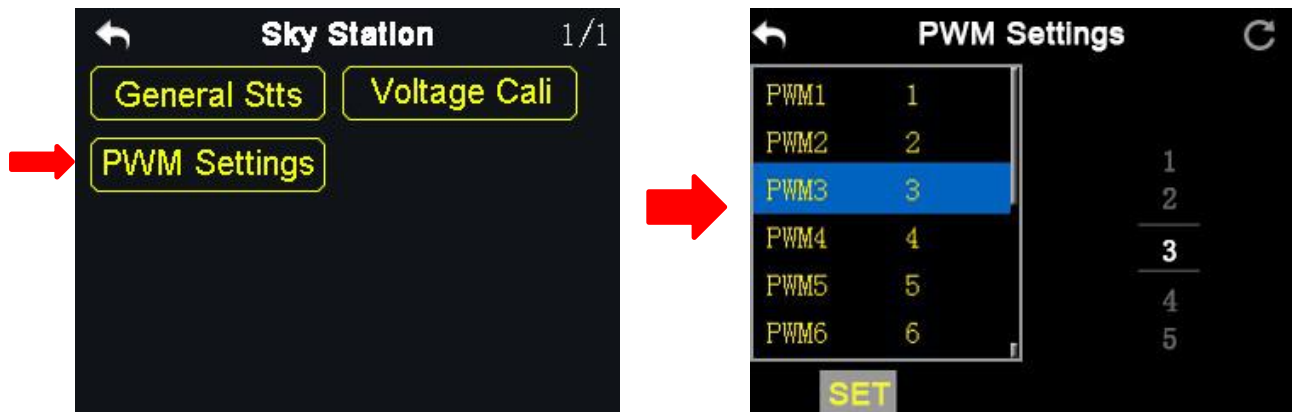

In the DK32S transmitter and the PWM mode, users can redefine the output channel of the sky station (channel 1-9 in default), so that if the channel 9 is already working in SBUS or PPM mode, the PWM ports 1 to 8 can still output to the channels 1 to 16 of the transmitter.

Steps

1. Power on the transmitter and the sky station, make sure that they are linked with each other;
2. The PWM port 1 of the transmitter is mapped to the PWM port 1 of the sky station, the PWM port 2 of the transmitter is mapped to the PWM port 2 of the sky station...and so on;
3. In the “PWM Settings” menu, tap on a PWM port and select a channel through the virtual turntable in the screen according to your requirement;
4. Tap on “SET” to finish.

8 Video Transmission / Datalink Settings

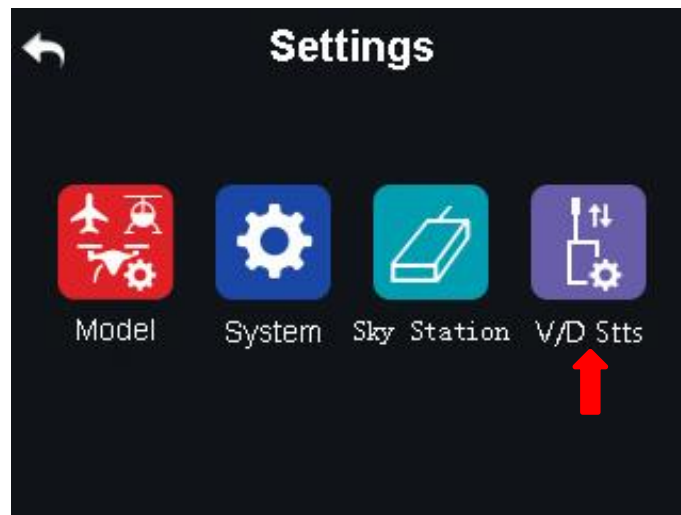

Functions

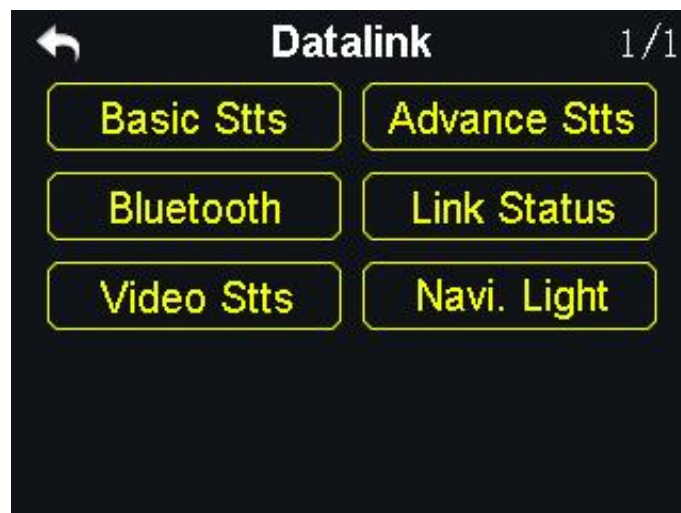

Basic Stts (Basic Settings): Set basic functions of the datalink module.

Advance Stts (Advanced Settings): Set the auto link function and the baud rate.

Bluetooth: Choose the Bluetooth module for your flight controller.

Link Status: Check the link status of the transmitter in real-time.

Video Stts (Video Transmission Settings): Set basic functions of the video transmission module.

Navi. Light (Navigation Light): Set the basic functions of the navigation light.

8.1 Basic Settings

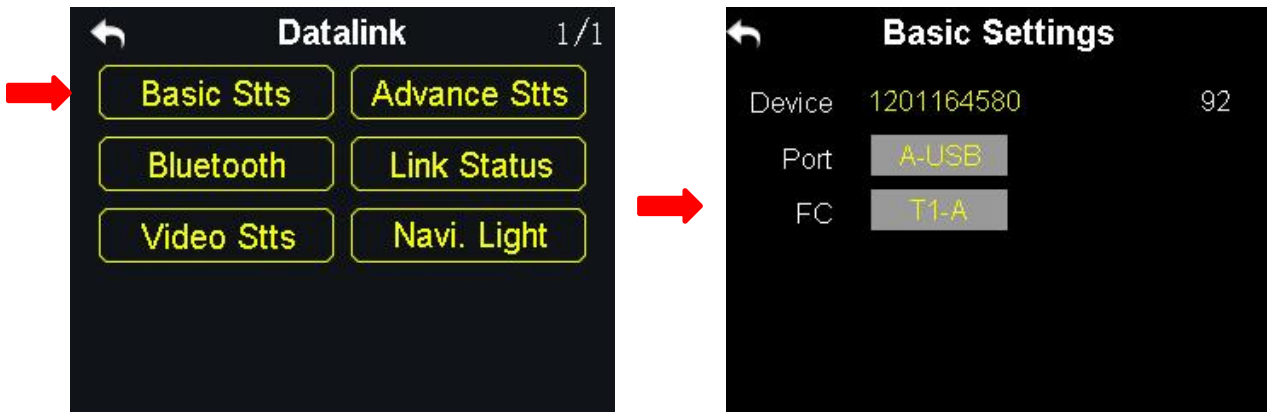

Functions

Device: Displays the serial number of the datalink module.

Port: Select a way of the transmitter output to a smartphone or a tablet. Available ports: A-USB output, Micro-USB output and Bluetooth output.

Flight Controller: Select a flight controller.

The DK32S transmitter supports all major flight controllers in market such as TOPXGUN (T1-A), WOOZOOM (THEONE-A), EFY (FINIX200M), BOYING (PALADIN), CHIAO (MATRIX), JIYI (K3-A), CFUAS (C1-A) and other flight controllers under open source Mavlink agreement such as PIX and APM.



⚠ CAUTION

Before connecting the Micro-USB port of the transmitter to a smartphone or a tablet to communicate with the flight controller, you need to switch the port to Datalink.

Steps

In the “System Settings” menu, tap on “Port Settings”; tap on “Micro-USB” to switch the port to “Datalink”.

⦿ Mark: When you switch the Micro-USB port to “Datalink”, the transmitter can no longer communicate with PC through the port. If you are to communicate it with a computer for firmware upgrading, please switch it to “Parameter”.

8.2 Advanced Settings

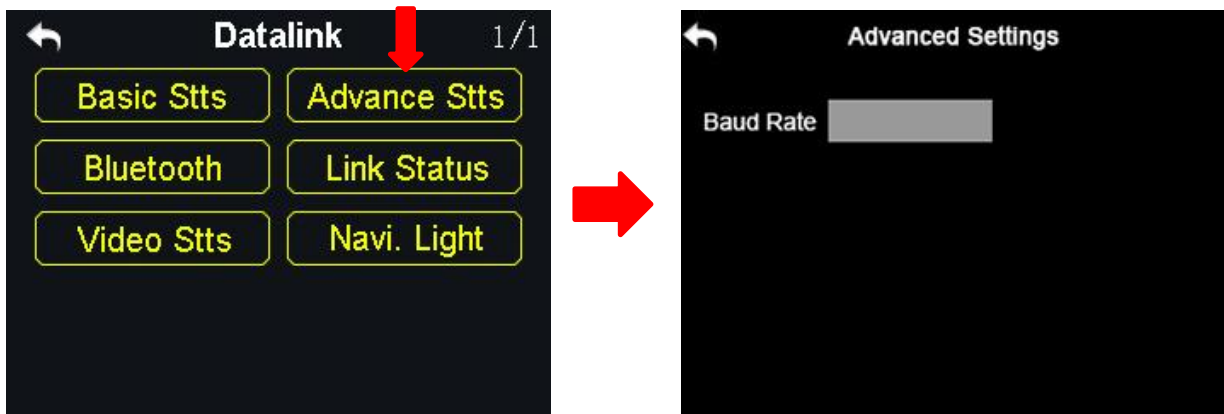

If your flight controller type was not in the list, you can set a baud rate to match your flight controller.

Steps

Make sure that the sky station is linked with the transmitter; in the “Advanced Settings” menu, tap on “Baud Rate” and input the baud rate.

8.3 Bluetooth

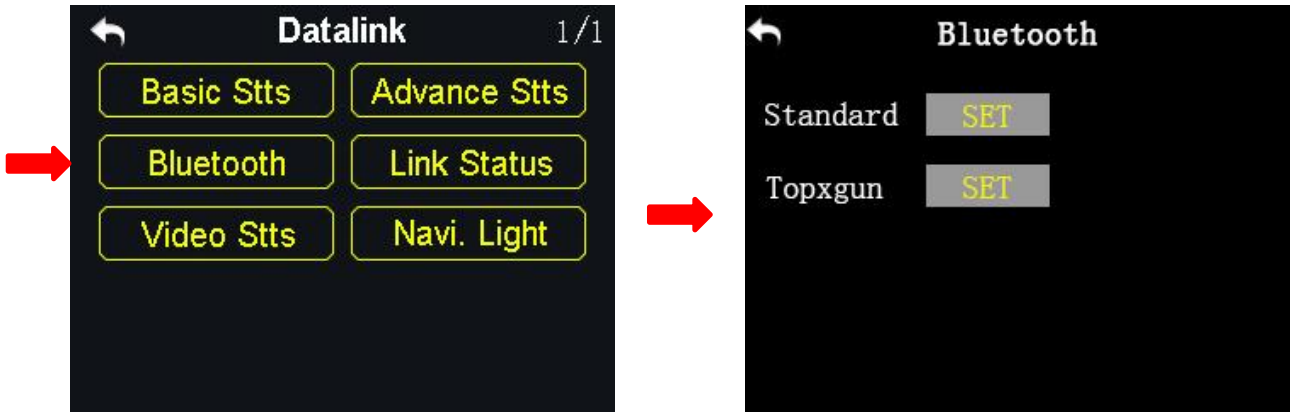

Please select the right external Bluetooth device according to your requiring flight controller.

Standard: For any flight controllers except the Topxgun T1-A.

Topxgun: For the Topxgun T1-A flight controller.

8.4 Link Status

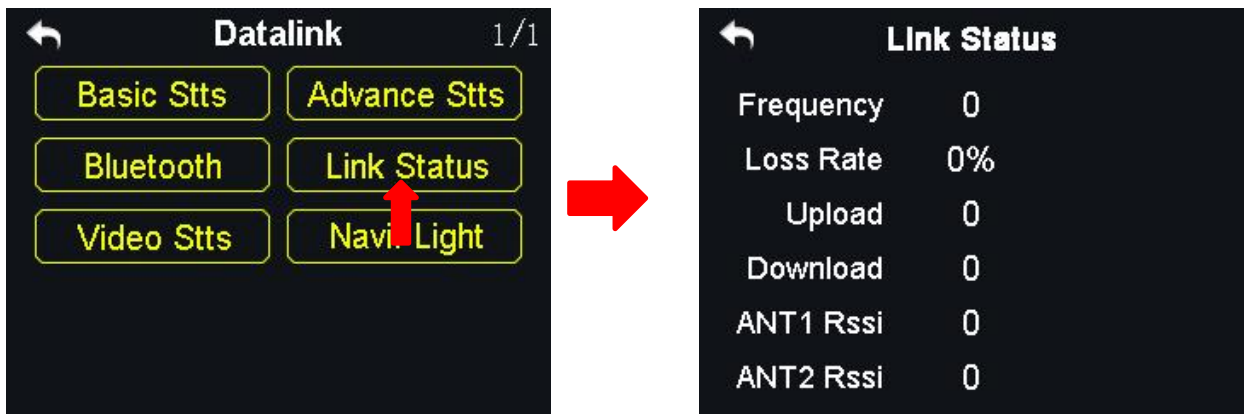

The link status function helps users check the detail signal and link status of the DK32S transmitter in real-time.

8.5 Video Transmission Settings

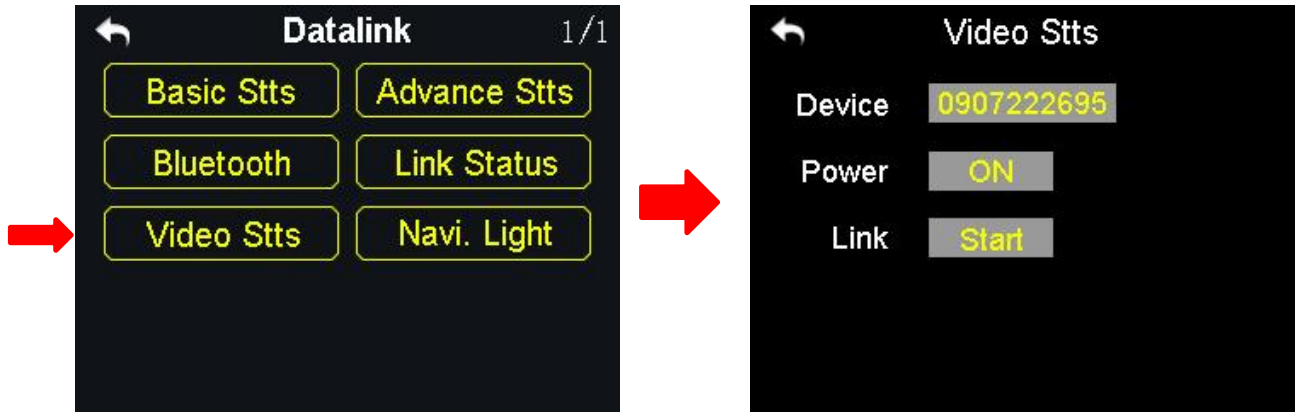

Users can check the serial number of the video transmission module and power on/off the function.

Function

Device: Displays the video transmission module's serial number.

Power: Power on/off the video transmission module.

Link: Link the transmitter with the video transmission module.

8.6 Navigation Light

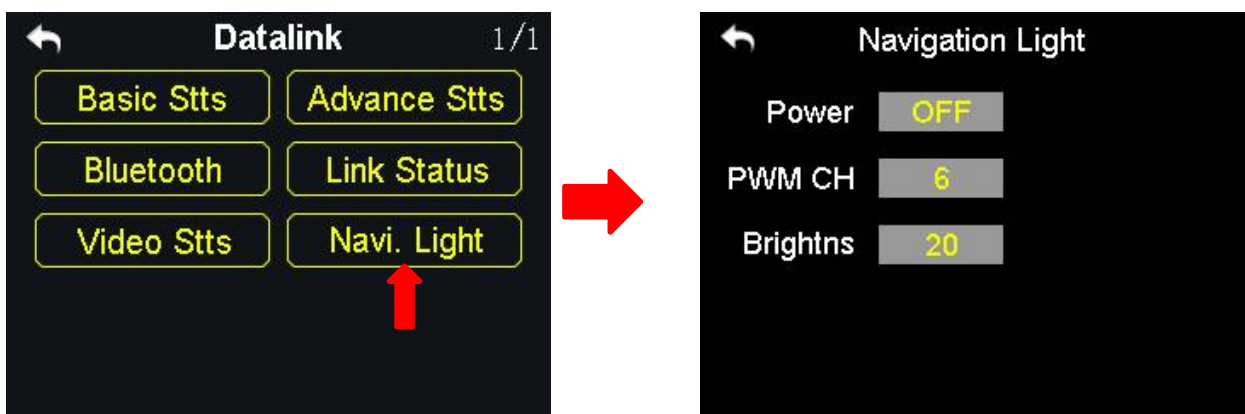

Users can power on/off the navigation light on the drone.

9 Firmware Upgrade

DK32S ground unit and DK32S air unit support firmware upgrading through PC software.

Before upgrading, it is necessary to prepare the tools, software, and firmware below.

- SIYI Assistant (PC Software)
- DK32S Ground Unit Firmware
- DK32S Ground Unit Voice File
- DK32S Air Unit Firmware

Mark

Above software and firmware can be downloaded from SIYI Official website or downloaded from SIYI DK32S / DK32 SE Google Drive Link (<https://drive.google.com/drive/folders/1R0qhW-dDNU9VovWvqNgjqt1aXEqWihph?usp=sharing>) or got from your dealer.

- Upgrade Cable (OTG Micro-USB to USB-A)

Mark

Above tools come with the DK32S package.

Firmware Upgrade Steps

Install “SIYI Assistant” into your Windows device.

Connect the OTG cable to the Windows device’s USB-A port and the DK32S ground unit’s Micro-USB port.

Run “SIYI Assistant” and switch to the “Upgrade” page to check DK32S ground unit’s current firmware version.

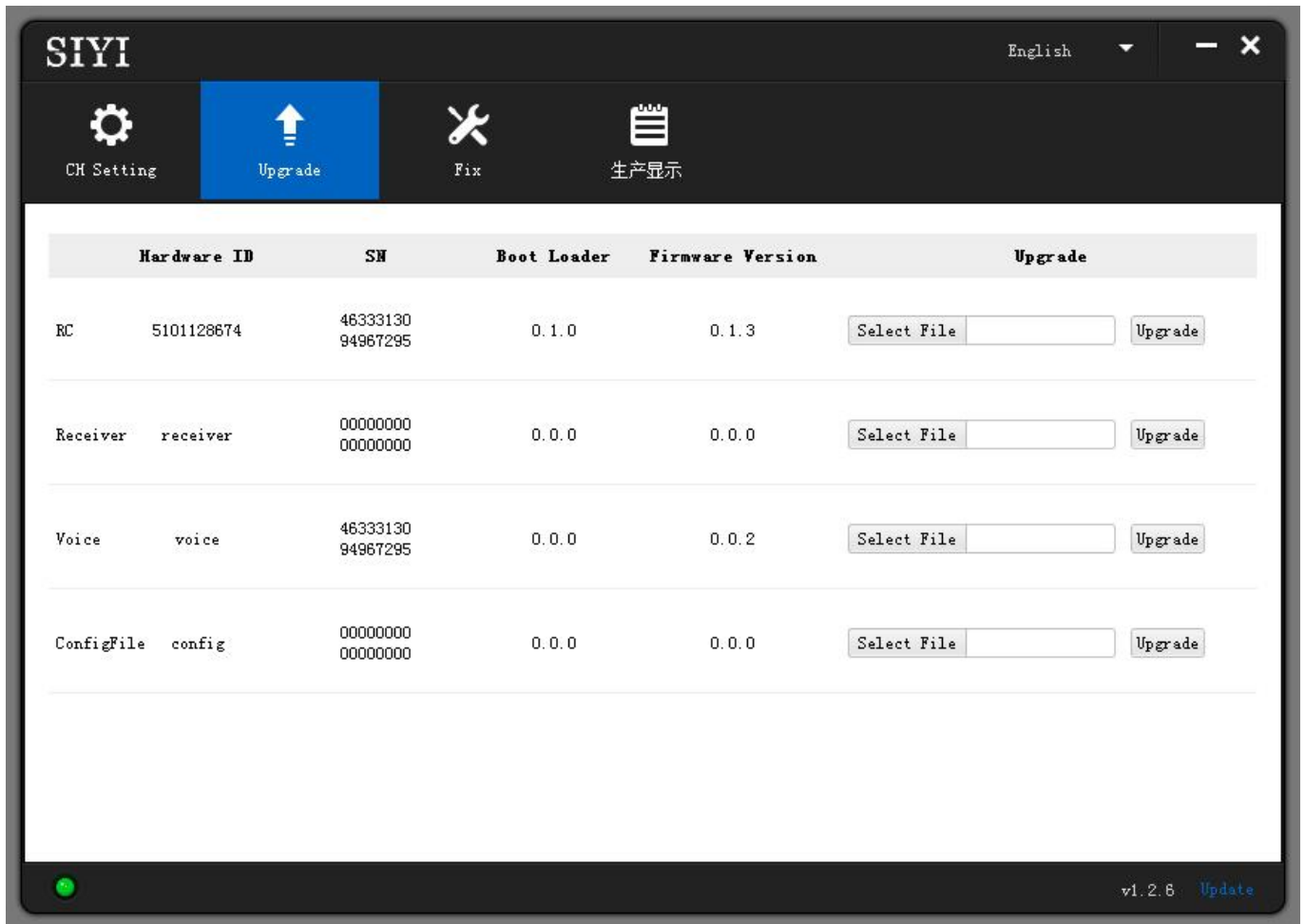

If the DK32S ground unit’s firmware is not the latest, then click the “Select File” button in the “RC” line to import the latest ground unit firmware. Then click “Upgrade” and wait till it is “100%” finished.

Disconnect DK32S ground unit from the Windows device. Use the OTG cable to connect DK32S air unit’s Micro-USB port to your Windows device’s USB-A port. Then repeat the above steps to upgrade air unit firmware.



Please choose the correct firmware according to the initial number in the boot loader number version. For instance, if the boot loader number is 5.1.0, then please choose the RF firmware version starting with number 5. If the boot loader number is 0.1.0, then please choose the RF firmware version with number 0.

Hardware ID	SN	Boot Loader	Firmware Version	Upgrade
RC 6801157681	3443384600000000	0.1.0	0.1.5	Select File Upgrade
Receiver receiver	0000000000000000	0.0.0	0.0.0	Select File Upgrade

When the ground unit RF firmware and the air unit RF firmware are different in initial numbers, they can still bind and work normally as long as their firmware version actually match.

Mark

Only when DK32S ground unit and air unit are bound, you can check both ground unit and air unit firmware in SIYI Assistant software.

10 After-sale Service

If there were any questions or problems using SIYI Technology's product, you can always try to send an email to SIYI Official A/S Center (support@siyi.biz) or consult your sales representative or dealer for answers or solutions.

8.1 Repair Service

If your purchased SIYI products cannot work properly, please contact SIYI Official A/S Center for consulting.

Usually there are two situations for acquiring repair service.

- Product Defect
- Product Damage

SIYI products under the two situations can be sent back to SIYI for repairing. Defect products with valid warranty can be repaired for free. Defect products without valid warranty or damaged products should be charged of repair fees after repairing. Please refer to SIYI's Official A/S Quotation for detail.

8.2 Warranty

SIYI Technology guarantees that, subject to the following conditions, Return & Refund Service, Replacement Service, and Warranty Repair Service can be requested. Please contact SIYI directly (support@siyi.biz or your sales manager) or authorized SIYI dealer for more detail.

8.2.1 7-Day Return & Refund

You can request Return & Refund Service:

Within seven (7) days of receiving a product if the product has no manufacturing defect, has not been activated and is still in new or like-new condition.

Within seven (7) days of receiving a product if the product has a manufacturing defect.

Return & Refund Service will not be provided where:

It is requested beyond seven (7) calendar days of receiving a product.

A product sent to SIYI for Return & Refund Service does not include all original accessories, attachments or packaging, or any item is not in new or like-new condition, i.e., with cracks, dents, or scratches.

A legal proof of purchase, receipt or invoice is not provided or is reasonably believed to have been forged or tampered with.

Any fault or damage of the product is caused by unauthorized use or modification of the product, including exposure to moisture, entry of foreign bodies (water, oil, sand, etc.) or improper installation or operation.

Product labels, serial numbers, waterproof marks, etc. show signs of tampering or alteration.

Damage is caused to the product by uncontrollable external factors, including fire, floods, high winds, or lightning strikes.

A product is not delivered to SIYI within seven (7) calendar days after Return & Refund Service confirmation is sent from SIYI.

Other circumstances stated in this policy.

8.2.2 15-Day Replacement

You can request Replacement Service:

Within fifteen (15) calendar days of receiving the product if the product has sustained a substantial damage in transit, provided always that the damage proof issued by the carrier can be provided to SIYI.

Within fifteen (15) calendar days of receiving the product if the product does not match the original description of the product in one or more significant respects.

Within fifteen (15) calendar days of receiving the product if the product suffers performance failure.

Replacement Service will not be provided where:

Service is requested more than fifteen (15) calendars days after receiving a product.

Legal proof-of-purchase, receipts, or invoices are not provided, or are reasonably believed to have been forged or tampered with.

A product sent to SIYI for replacement does not include all original accessories, attachments, and packaging, or contains items damaged by user error.

A product is found to have no defects after all appropriate tests are conducted by SIYI.

Any fault or damage of the product is caused by unauthorized use or modification of the product, including exposure to moisture, entry of foreign bodies (water, oil, sand, etc.) or improper installation or operation.

Damage is caused by uncontrollable external factors, including fires, floods, high winds, or lightning strikes.

Received product has not been sent back to SIYI seven (7) calendar days after replacement confirmation from SIYI.

Proof of damage during transit issued by the carrier cannot be provided.

Other circumstances stated in this policy.

8.2.3 1-Year Warranty Repair

You can request warranty repair service:

If a product does not function as warranted during the warranty period, you may obtain after-sales service by contacting SIYI's service center. You will need to provide a valid proof-of-purchase, receipt, or order number for the warranty service.

Charges may apply for services not covered by this Limited Warranty. Please contact SIYI for information specific to your location.

Please note that the warranty service is only available in the respective SIYI service regions where you purchased your SIYI product.

Warranty Repair service will not be provided where:

Crashes or fire damage caused by non-manufacturing factors, including but not limited to pilot errors.

Damage caused by unauthorized modification, disassembly, or shell opening not in accordance with official instructions or manuals.

Damage caused by improper installation, in correct use, or operation not in accordance with official instructions or manuals.

Damage caused by non-authorized service provider.

Damage caused by unauthorized modification of circuits and mismatch or misuse of the battery and charger.

Damage caused by operation in bad weather (i.e., strong winds, rain, sand/dust storms, etc.)

Damage caused by operating the product in an environment with electromagnetic interference (i.e., in mining areas or close to radio transmission towers, high-voltage wires, substations, etc.)

Damage caused by operating the product in an environment suffering from interference from other wireless devices (i.e., transmitter, video-downlink, Wi-Fi signals, etc.)

Damage caused by reliability or compatibility issues when using unauthorized third-party parts.

Damage caused by operating the unit with a low-charged or defective battery.

Products or parts with an altered identification label or from which the identification label has been removed.

SIYI Technology (Shenzhen) Co., Ltd

Business Inquiry: info@siyi.biz

Phone: +86 400 838 2918

A/S Center: support@siyi.biz